

# CONTENTS

I. Product .....	1
1.1 Product model naming rule.....	1
1.2 Optional function naming rule.....	2
1.3 Nameplate.....	4
1.4 Appearance.....	4
1.5 Technical Specifications .....	5
1.6 Designed Standards for Implementation.....	6
1.7 Safe Instructions.....	7
1.8 Precautions.....	8
1.9 Examination and Maintenance.....	10
II. Keypad panel.....	11
2.1 Panel Illustrations.....	11
2.2 Panel Structure.....	12
2.3 Panel Operating .....	13
2.4 Parameters Setting .....	14
2.5 Function Codes Switchover In/Between Code-Groups.....	15
2.6 Operating instructions of 4-line LCD interface switch.....	16
2.7 Panel Display .....	19
III. Installation & Connection .....	20
3.1 Installation.....	20
3.2 Connection .....	20
3.3 Measurement of main circuit voltage, current and power.....	24
3.4 Function of Control Terminals.....	26
3.5 Wiring Recommended.....	29
3.6 Lead Section Area of Protect Conductor(grounding wire) .....	30
3.7 Overall connection.....	30
3.8 Basic methods of suppressing the noise .....	31

IV. Operation and Simple Running .....	36
4.1 Basic conception.....	36
4.2 Keypad panel and operation method.....	37
4.3 Illustration of basic operation.....	40
V. Function Parameters .....	46
5.1 Basic Parameters.....	46
5.2 Operation Control .....	55
5.3 Multifunctional Input and Output Terminals.....	63
5.4 Analog Input and Output.....	74
5.5 Pulse input and output.....	77
5.6 Multi-stage Speed Control.....	80
5.7 Auxiliary Functions.....	81
5.8 Malfunction and Protection.....	90
5.9 Parameters of the motor.....	95
5.10 Communication parameters.....	99
5.11 PID parameters.....	102
5.12 Torque control parameters.....	108
5.13 Parameters Display.....	110
Appendix 1 Trouble Shooting.....	112
Appendix 2 Reference wiring of water system.....	115
Appendix 3 Products and Structure .....	118
Appendix 4 Selection of Braking Resistance .....	120
Appendix 5 Communication Manual.....	121
Appendix 6 Zoom Table of Function Code .....	130
Appendix 7 Master/slave control .....	157

...

# I. Product

This manual offers a brief introduction of the installation connection for EP66 series inverters, parameters setting and operations, and should therefore be properly kept. Please contact manufacturer or dealer in case of any malfunction during application.

## 1.1 Product model naming rule

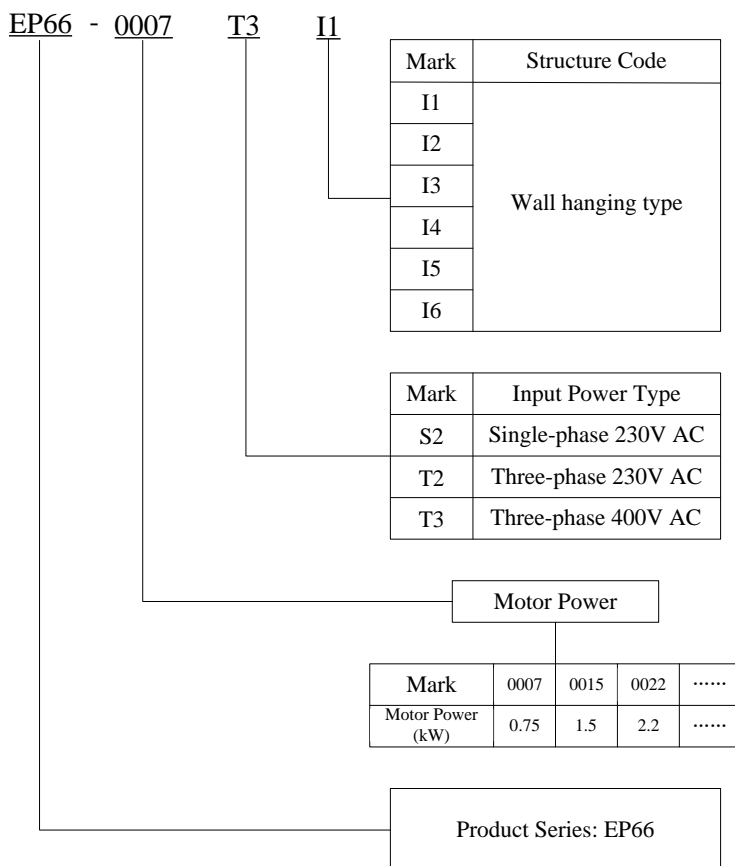

## 1.2 Optional function naming rule

U1	F15	AD01	G1	B1	R3				
						Filter type	R3	EMC C3 level filter	Note 1
						Braking mode	B1	Dynamic braking	Note 2
						Control unit type	G1	Master switch	Note 5
						Keypad type	AD01	Segment LCD	Note 3
						Communication	F15	Modbus terminal block	Note 4
						Certificate type	U1	CE	Note 4

**Note 1:** R3: EMC C3 level, test condition: power cable is 25m shielded wire.

**Note 2:** Dynamic braking: The inverter model for S2 and T2 is optional;  
The inverter model for T3: Standard ( $\leq 15\text{kW}$ ); Optional ( $\geq 18.5\text{kW}$ )

**Note 3:** EP66 supports 4 kinds of keypad type, user can select as needed;

Keypad code	Keypad definition
AD01	AD English 1-line LCD keypad without potentiometer
AD02	AD English 4-line LCD keypad without potentiometer
AD03	AD Chinese 1-line LCD keypad without potentiometer
AD04	AD Chinese 4-line LCD keypad without potentiometer

**Note 4:** certification and communication type

Structure code	Certificate	Certificate code	Communication	Communication code
I1~I3	U5	CE+UL	F2	Modbus
	U1	CE	F15	CAN communication (free protocol) +Modbus
I4~I6	U1	CE	F15	CAN communication (free protocol) +Modbus

**Note 5:** Master control switch G1 is optional accessory for 0.4kW~15kW. Drives of 18.5kW~90kW have no such optional accessory, the reference specifications show in the table below:

Product Model	Master Control Switch Model
EP66-0004S2I1	NL025/3ZM/Z33(25A)
EP66-0007S2I1	
EP66-0015S2I1	
EP66-0022S2I1	
EP66-0004T2I1	
EP66-0007T2I1	
EP66-0015T2I1	
EP66-0022T2I1	
EP66-0004T3I1	
EP66-0007T3I1	
EP66-0015T3I1	
EP66-0022T3I1	
EP66-0030T3I1	
EP66-0040T3I1	
EP66-0055T3I2	
EP66-0075T3I2	
EP66-0110T3I3	NL063/3ZM/Z33(63A)
EP66-0150T3I3	

Note 6:15kw and below 15kw drives do not have DC choke, 18.5~90kW drives have standard built-in DC choke.

### 1.3 Nameplate

Taking the EP66 series 0.75kW inverter with 3-phase 400V input for instance, including remote segment LCD keypad to display, built-in braking unit and filter, its nameplate is illustrated as Fig 1-1.

3Ph: 3-phase input; 400V, 50/60Hz: input voltage range and rated frequency.

3Ph: 3-phase output; 2.0A, 0.75kW: rated output current and power;

0.50~650.0Hz: Output frequency range;



<b>EU<sup>®</sup> DRIVES</b>		<b>EU<sup>®</sup> DRIVES ELECTRIC CO.,LTD</b>				
<b>MODEL</b>	EP66-0007T3I1		<b>OPTION</b>	U5F2AD01(G1)B1R3		
<b>INPUT</b>	3 PH	AC	380-480 V	50/60 Hz		
<b>OUTPUT</b>	3 PH	2.0 A	0-Input V			
	0.75 kW					
 		 EP660007T3I5A13000025 SW NO. 1.02			Made In China	

Fig 1-1 Product Nameplate

### 1.4 Appearance

The external structure of EP66 series inverter is classified into plastic and metal housings. Wall hanging type and cabinet type are adopted. Good poly-carbon materials are adopted through die-stamping for plastic housing with nice form, good strength and toughness.

Taking EP66-0007T3I1 for instance, the external appearance and structure are shown as in Fig 1-2.

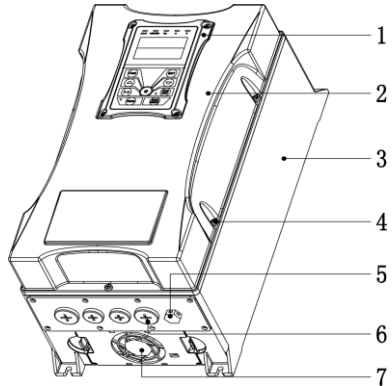

Fig 1-2 Appearance and Structure

1	2	3	4	5	6	7
Keypad	Cover	Radiator	Screw	Vent	Cable gland	Fan

Connection of remote cable is shown as following:

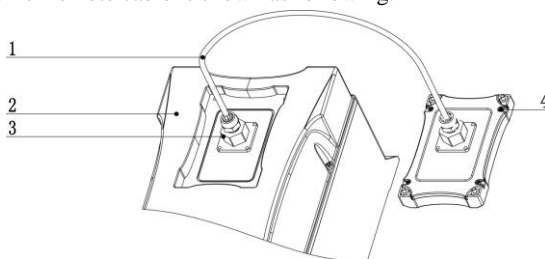

Fig 1-3 Remote control cable structure

1	2	3	4
Cable	Inverter	Waterproof connector	Remote keypad

When ordering AD-A remote cable package, please specify cable type and cable length. TYW-XXXX, TYW stands for 8-core net cable, XXXX stands for cable length, and the unit is mm.

Note: When remote control is required, make sure to remove the waterproof connector firstly, and open the snap joint of plug, then detach the cover.

## 1.5 Technical Specifications

Table1-1 Technical Specifications for EP66 Series Inverters

	Items	Contents
Input	Rated Voltage Range	T3 380V-480V +10%/-15% ; S2/T2 220V-240V ±15%
	Rated Frequency	50/60Hz
Output	Rated Voltage Range	3-phase 0-Input
	Frequency Range	0.50~650.0Hz
Control Mode	Carrier Frequency	800-16000Hz; Fixed carrier-wave and random carrier-wave can be selected by F159.
	Input Frequency Resolution	Digital setting: 0.01Hz; Analog setting: Max frequency × 0.1%
	Control Mode	Sensorless Vector Control (open-loop vector control), V/F control, PMSM sensorless vector control
	Start Torque	0.5 Hz / 150% (SVC), 5% of rated speed / 100% of rated torque (PMSM)
	Speed-control Scope	1:100 (SVC), 1:20 (PMSM)
	Steady Speed Precision	±0.5% (SVC)
	Torque Control Precision	±5% (SVC)
	Overload Capacity	150% rated current, 60 seconds.
	Torque Elevating	Auto torque promotion, manual torque promotion includes 1-20 curves.

	V/F Curve	3 kinds of modes: beeline type, square type and under-defined V/F curve.
	Startup mode	Direct startup, speed track startup (V/F control)
	DC Braking	DC braking frequency: 0.2~50.00 Hz, braking time: 0.00~30.00s
	Jogging Control	Jogging frequency range: Min frequency~ Max frequency, Jogging acceleration/deceleration time: 0.1~30.00s
	Auto Circulating Running and multi-stage speed running	Auto circulating running or terminals control can realize 15-stage speed running.
	Built-in PID adjusting	Easy to realize a system for process closed-loop control
	Auto voltage regulation (AVR)	When source voltage changes, the modulation rate can be adjusted automatically, so that the output voltage is unchanged.
Operation Function	Frequency Setting	Potentiometer or external analog signal (0~5V, 0~10V, 0~20mA); keypad (terminal) ▲ / ▼ keys, external control logic and automatic circulation setting.
	Start/Stop Control	Terminal control, keypad control or communication control.
	Running Command Channels	3 kinds of channels from keypad panel, control terminal and MODBUS.
	Frequency Source	Frequency sources: given digit, given analog voltage, given analog current and given MODBUS
	Accessorial frequency Source	6 kinds of accessorial frequency
Optional	Built-in EMI filter, built-in braking unit, Modbus, tele-control panel	
Protection Function	Input phase loss, Output phase loss, input under-voltage, DC over-voltage, over-current, inverter over-load, motor over-load, current stall, over-heat, external disturbance, under-load, pressure control, analog line disconnected, oPEn fault, STo function .	
Display	Output frequency, rotate-speed (rpm/min), output current, output voltage, DC bus voltage, PID feedback value, PID setting value, linear-velocity, types of faults, and parameters for the system and operation; LED indicators showing the current working status of inverter.	
Environment Conditions	Equipment Location	In harsh conditions, prevent dust of other thing from entering inverter totally. Completely protected against jets of water and heavy waves. Meeting EN 60529 standard.
	Environment Temperature	-10℃~+40℃
	Vibration Strength	Below 0.5g (acceleration)
	Height above sea level	1000m or below(derating use if higher than 1000m)
Protection level	IP66	
Class of pollution	PD2	
Applicable Motor	0.4~90kW	

## 1.6 Designed Standards for Implementation

- IEC/EN 61800-5-1: 2007 Adjustable speed electrical power drive systems safety requirements.
- IEC/EN 61800-3: 2004/+A1: 2012 Adjustable speed electrical power drive systems-Part 3: EMC product standard including specific test methods.
- IEC 529(1989)/EN60529 Degree of protection provided by enclosure (IP code)



## 1.7 Safe instructions

- Please check the model in the nameplate of the inverter and the rated value of the inverter. Please do not use the damaged inverter in transit.
- Installation and application environment should be free of rain, drips, steam, dust and oily dirt; without corrosive or flammable gases or liquids, metal particles or metal powder. Environment temperature within the scope of  $-10^{\circ}\text{C} \sim +40^{\circ}\text{C}$ .
- Please install inverter away from combustibles.
- Do not drop anything into the inverter.
- Inverter is installed in a control cabinet, and smooth ventilation should be ensured and inverter should be installed vertically, upside-down is not allowed (Fig 1-4). If there are several inverters in one cabinet, in order to ensure ventilation, please install inverters side by side. If it is necessary to install several inverters up and down, please add heat-insulation plate(Fig 1-5).

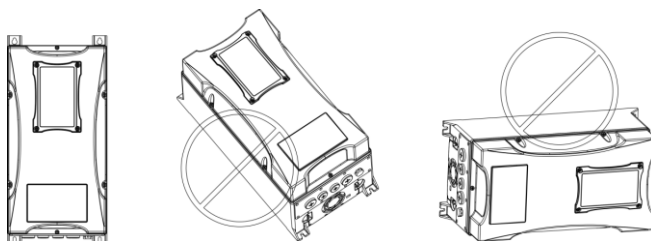

Fig 1-4 Installation Diagram

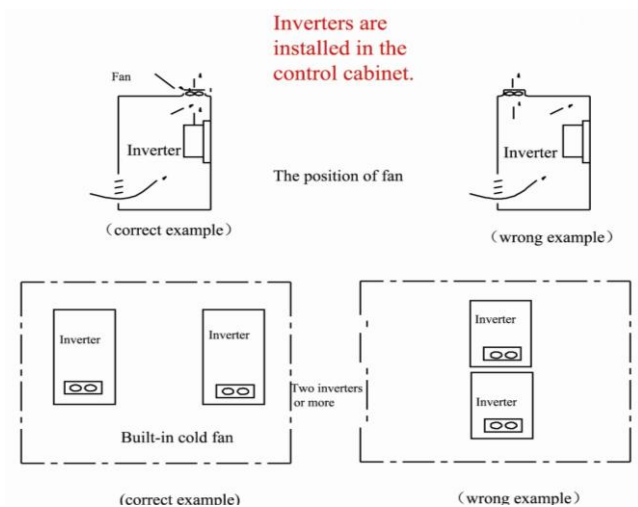

Fig 1-5 Installation in Cabinet Diagram

## 1.8 Precautions

### 1.8.1 Instructions for use

- Never touch the internal elements within 15 minutes after power off. Wait till it is completely discharged.
- Input terminals L1/R, L2/S, L3/T are connected to power supply of 400V/230V (L1, L2 are connected to 230V) while output terminals U, V and W are connected to motor.
- Proper grounding should be ensured with grounding resistance not exceeding 4Ω; separate grounding is required for motor and inverter. Grounding with series connection is forbidden.
- There should be separate wiring between control loop and power loop to avoid any possible interference.
- Signal line should not be too long to avoid any increase with common mode interference.
- If circuit breaker or contactor needs to be connected between the drive and the motor, be sure to operate these circuit breakers or contactor when the drive has no output, to avoid damaging of drive.
- Before using the drive, the insulation of the motors must be checked, especially, if it is used for the first time or if it has been stored for a long time. This is to reduce the risk of the drive from being damaged by the poor insulation of the motor.
- Do not connect any varistor or capacitor to the output terminals of the drive, because the drive's output voltage waveform is pulse wave, otherwise tripping or damaging of components may occur; in addition, do not install circuit breaker or contactor at the output side of the drive as shown in Fig 1-6.

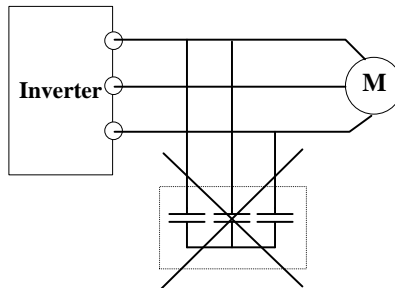

Fig 1-6 Capacitors are prohibited to be used

- Derating must be considered when the drive is installed at high altitude, greater than 1000m. This is because the cooling effect of drive is deteriorated due to the thin air, as shown in Fig. 1-7 that indicates the relationship between the elevation and rated current of the drive.

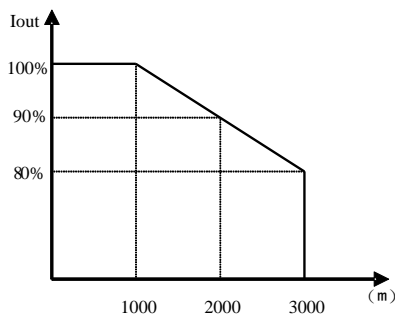

Fig 1-7 Curve Chart of derating rated current with altitude

- Because inverter will release heat in the running process, user must operate the inverter when inverter is in the cooling status. The overheat warning is shown in Fig1-8.



Fig 1-8 Overheat warning

### 1.8.2 Special Warning!!

- Never touch high-voltage terminals inside the inverter to avoid any electric shock.
- Before inverter is powered on, please be sure that input voltage is correct.
- Please do not connect input power supply onto U, V, W or  $\text{tern } \oplus$  ls.
- Please do not install inverter directly under sunshine, do not block up the cooling hole.
- All safety covers should be well fixed before inverter is power connected, to avoid any electric shock.
- Only professional personnel are allowed for any maintenance, checking or replacement of parts.
- No live-line work is allowed.

## 1.9 Examination and Maintenance

### 1.9.1 Periodic checking

- Cooling fan and wind channel should be cleaned regularly to check whether it is normal; remove the dust accumulated in the inverter on a regular basis.
- Check inverter's input and output wiring and wiring terminals regularly and check if wirings are ageing.
- Check whether screws on each terminals are fastened.
- Check whether inverter is corrosive.

### 1.9.2 Storage

- Please put the inverter in the packing case of manufacture.
- If inverter is stored for long time, please charge the inverter within half a year to prevent the electrolytic capacitors damaged. The charging time should be longer than 5 hours.

### 1.9.3 Daily Maintenance

Environment temperature, humidity, dust and vibration would decrease the life of inverter. Daily maintenance is necessary to inverters.

#### **Daily inspecting:**

- Inspecting for noise of motor when it is working.
- Inspecting for abnormal vibration of motor when it is working.
- Inspecting for the installing environment of inverter.
- Inspecting for the fan and inverter temperature.

#### **Daily cleaning:**

- Keep the inverter clean. Clean surface dust of inverter to prevent dust, metal powder, oily dirt and water from dropping into the inverter.

## II. Keypad panel

Keypad panel and monitor screen are both fixed on keypad controller. Two kinds of controllers (segment LCD and four-line LCD) are available for EP66 series inverters. Refer to note for Fig2-1.

### 2.1 Panel Illustration

The panel covers three sections: data display section, status indicating section and keypad operating section, as shown in Fig. 2-1.

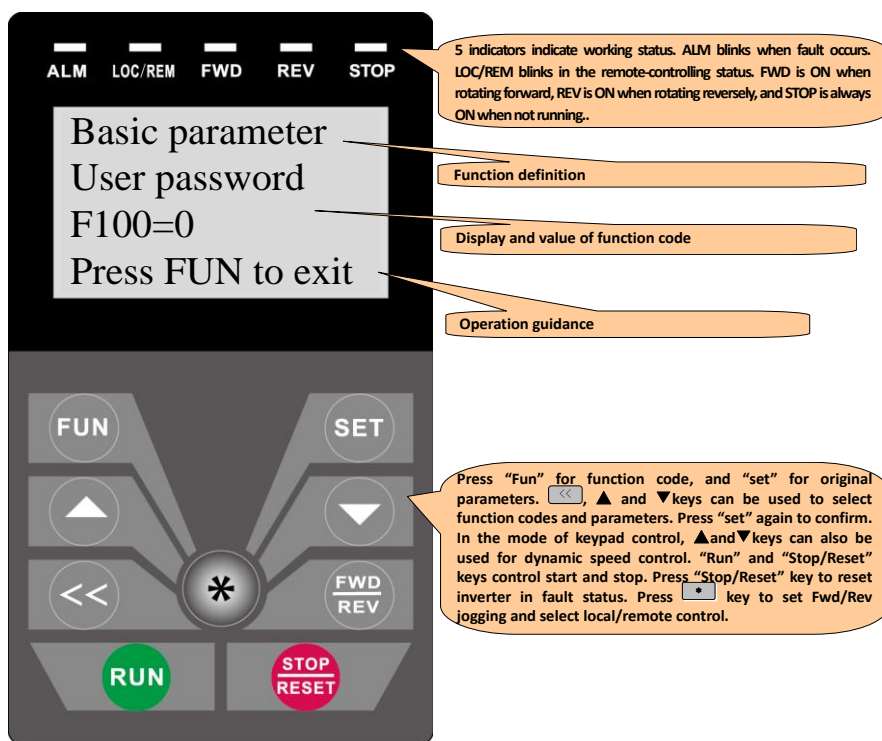

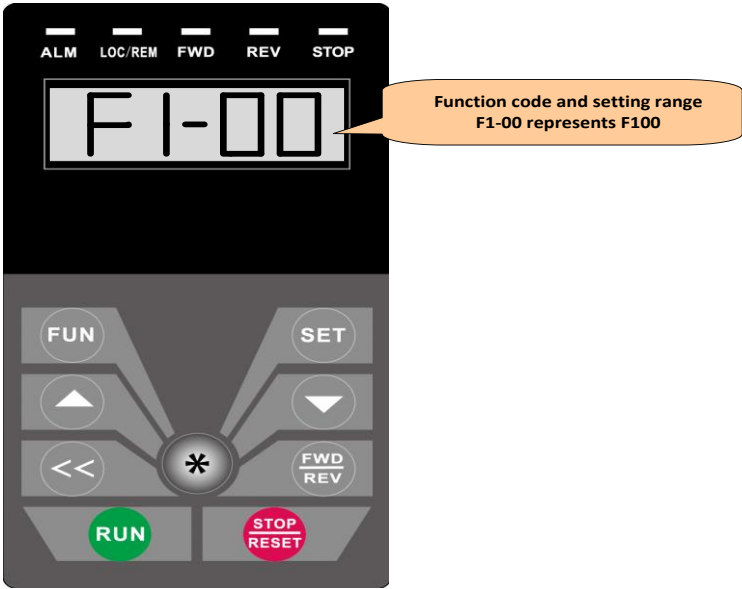
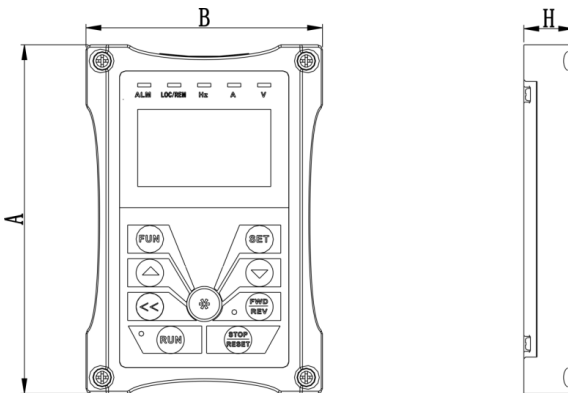

Fig.2-1 Operation Panels

Instructions for operation panel:  
 Four-line LCD and segment LCD are only suitable for EP66 series inverters.

## 2.2 Panel structure

1. structure diagram



## 2. Structure size (Unit: mm)

Code	LCD	A	B	H
AD01/AD03	Segment LCD	140	95	20
AD02/AD04	Four-line LCD			

Segment LCD: AD (structure)-A (cable port)-01(one-line);

Four-line LCD: AD (structure)-A (cable port)-02(four-line).

## 3. Port of control panel

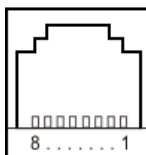

Pins	1	2	3	4	5	6	7	8
8 core	Reserved	5V	5V GND	5V GND	Signal 1	Signal 2	Signal 3	Signal 4

4. The default remote-control wire length is 1m. If on the series interference of occasion, or the length is longer than 3m, please put a magnetic ring on the wire to avoid interference.

## 2.3 Panel Operating



All keys on the panel are available for user. Refer to Table 2-1 for their functions.

Table 2-1

Uses of Keys

Keys	Names	Remarks
	Fun	To call function code and switch over display mode.
	Set	To call and save data.
	Up	To increase data (speed control or setting parameters)
	Down	To decrease data (speed control or setting parameters)
	Run	To start inverter;
	Stop or reset	To stop inverter; to reset in fault status;
	Forward or reverse	Switchover between forward and reverse.
	Shift key	Shift and displaying items switchover (Four-line LCD)
	Multi-functional key	FWD/REV jogging and local/remote can be selected by multi-functional key, please refer to F643.















### Operating structure of four-line LCD:

The display interface of keypad will turn to malfunction interface when inverter malfunctions. At this time press the  to check current, voltage and frequency. The specific values will be displayed on the fourth line of malfunction interface if the malfunction code is displayed as anyone of OC, OC1, OE, OL1 and OL2. “?A”, “?V” and “?Hz” for current, voltage and frequency respectively will be displayed if the displayed malfunction code is not one of above 6 malfunctions. Press the  to check the malfunction type and status of second (third) –to-last. After clearing the faults, keypad cannot response reset function but only shift function when pressing Reset/Stop key in non-malfunction interface; keypad can response reset function when pressing Reset/Stop key only in malfunction interface.

## 2.4 Parameters Setting

This inverter has numerous function parameters, which the user can modify to effect different modes of operation control. User needs to realize that if user sets password valid (F107=1), user’s password must be entered first if parameters are to be set after power off or protection is effected, i.e., to call F100 as per the mode in Table 2-2 and enter the correct code. User’s password is invalid before delivery, and user could set corresponding parameters without entering password.

**Table 2-2 Steps for Parameters Setting**

Steps	Keys	Operation	Display
1		Press “Fun” key to display function code	
2	 or 	Press “Up” or “Down” to select required function code	
3		To read data set in the function code	
4	 or 	To modify data	
5		To display corresponding function code after saving the set data	
		To display the current function code	

The above-mentioned step should be operated when inverter is in stop status.



## 2.5 Function Codes Switchover in/between Code-Groups

It has more than 300 parameters (function codes) available to user, divided into 12 sections as indicated in Table 2-3.

**Table 2-3 Function Code Partition**

Group Name	Function Code Range	Group No.	Group Name	Function Code Range	Group No.
Basic Parameters	F1	1	Timing control and protection function	F7	7
Run Control Mode	F2	2	Parameters of the motor	F8	8
Multi-functional input/output terminal	F3	3	Communication function	F9	9
Analog signals and pulse of input/output	F4	4	PID parameter setting	FA	10
Multi-stage speed parameters	F5	5	Torque control parameters	FC	11
Subsidiary function	F6	6	Parameters display	H0	12



As parameters setting costs time due to numerous function codes, such function is specially designed as “Function Code Switchover in a Code Group or between Two Code-Groups” so that parameters setting become convenient and simple.

### The operation of segment LCD:

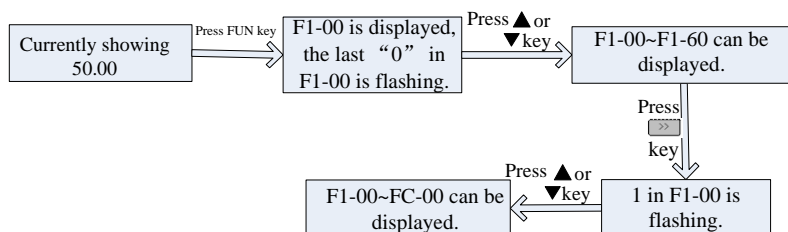
Press “Fun” key so that the keypad controller will display function code. If press “▲” or “▼” key then, function code will circularly keep increasing or decreasing by degrees within the group; if press  key, function code will change circularly between two code groups when operating the “▲” or “▼” key.



**The operation of four-line LCD:**

When function code shows F100 and the last “0” in F100 is flashing, after pressing  key, the middle “0” is flashing, then press  again, “1” in F100 is flashing, the flashing value can be changed by pressing “▲”/“▼” key.

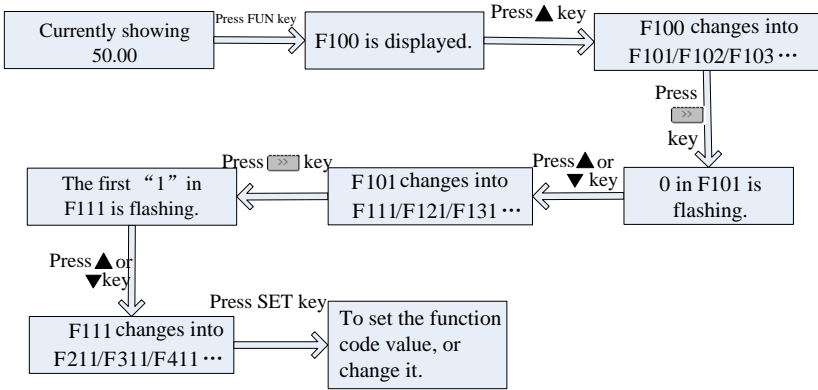

Fig 2-2 Switch over in a Code Group or between Different Code-Groups

**2.6 Operating instructions of 4-line LCD interface switch**

**2.6.1 Operating instructions of SET/FUN keys**

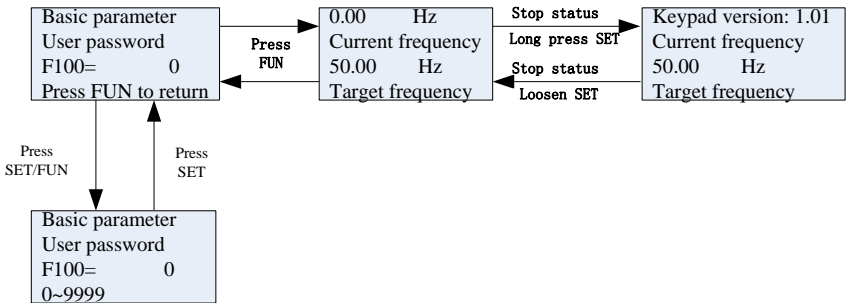

Fig 2-3 Operating flow chart of interface switch

## 2.6.2 Operating instructions of multifunction key

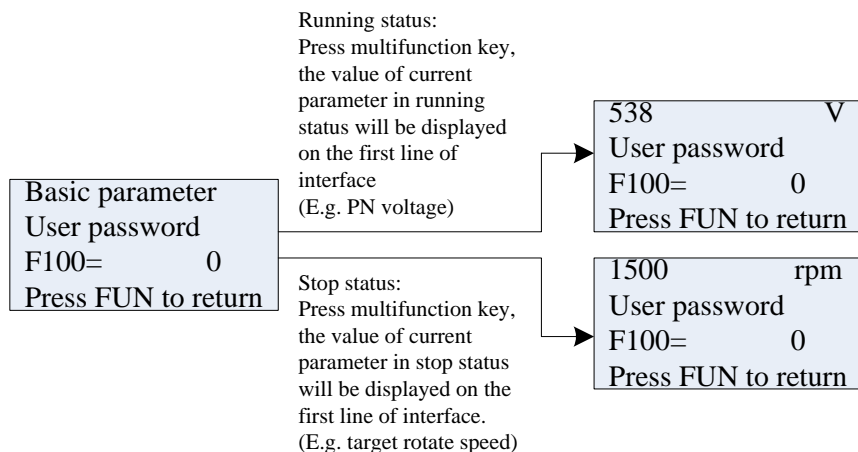

Fig 2-4 Operating flow chart of programming

## 2.6.3 Operating instructions of inverter status display

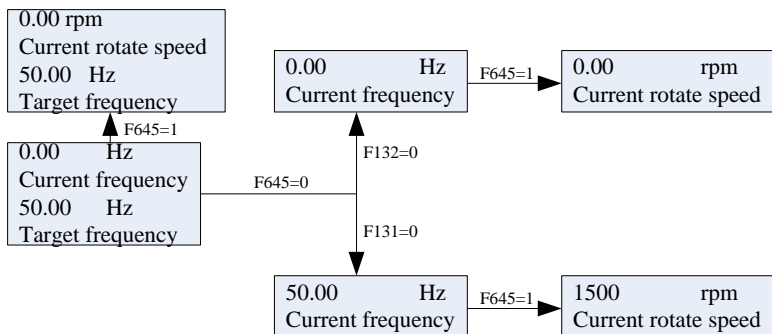

Fig 2-5 Operating flow chart of status parameter display

2.6.4 Regulating target frequency/target rotate speed by UP/DOWN keys in running status

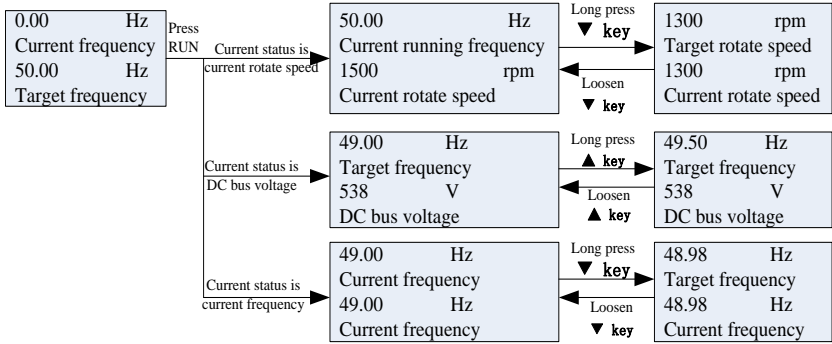

Fig 2-6 Operating flow chart of target frequency/rotate speed adjustments

2.6.5 Operating instructions of displayed malfunction interface

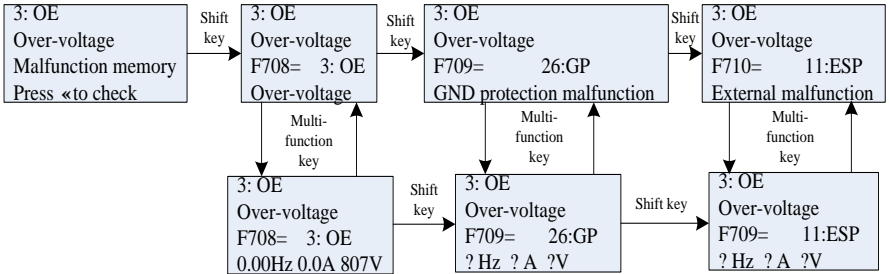

Fig 2-7 Operating flow chart of displayed malfunction interface

## 2.7 Panel Display

**Table 2-4 Items and Remarks Displayed on the Panel**

Items	Remarks
-HF- (Segment LCD)	It stands for resetting process and will display target frequency after reset.
Power on.... (Four-line LCD)	It stands for power on process.
OC, OC1, OE, OL1, OL2, OH, LU, PFO, PFI,PCE	Fault code, indicating “over-current OC”, “over-current OC1”, “over-voltage”, “inverter over-load”, “motor over-load” “over-heat”, “under-voltage for input”, “phase loss for output”, “phase loss for input” and “detuning fault” respectively.
AErr, EP, nP, Err5	Analog line disconnected, inverter under-load, pressure control, PID parameters are set wrong,
ESP	During two-line/three line running mode, “stop/reset” key is pressed or external emergency stop terminal is closed, ESP will be displayed.
oPEn	Terminal function is oPEn protection and oPEn terminal is disabled.
F152	Function code (parameter code).
10.00	Indicating inverter’s current running frequency (or rotate speed) and parameter setting values, etc.
50.00	Sparkling in stopping status to display target frequency.
0.	Holding time when changing the running direction. When “Stop” or “Free Stop” command is executed, the holding time can be canceled
A100, U100, u540	Output current (100A), output voltage (100V) and bus voltage (540V).
b*.*	PID feedback value is displayed.
o*.*	PID given value is displayed.
L***	Linear speed is displayed.
H ***	Radiator temperature is displayed.

### III. Installation & Connection

#### 3.1 Installation

Inverter should be installed vertically, as shown in Fig 3-1. Sufficient ventilation space should be ensured in its surrounding. Clearance dimensions (recommended) are available from Table 3-1 for installing the inverter.

**Table 3-1 Clearance Dimensions**

Model	Clearance Dimensions	
Hanging	A≥150mm	B≥50mm

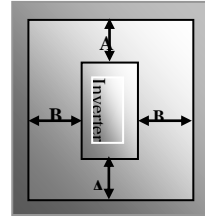
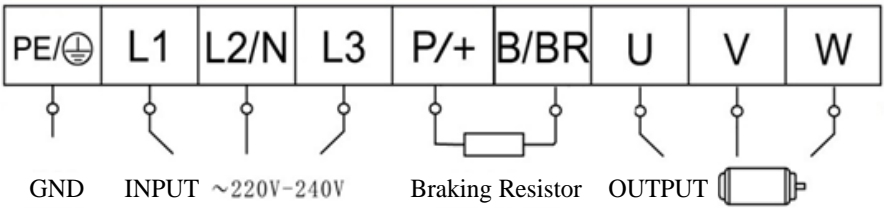

Fig 3-1 Installation Sketch

#### 3.2 Connection

- Connect R/L1, S/L2 and T/L3 terminals (L1 and L2 terminals for single-phase) with power source from network and to earthing, U, V and W terminals to motor.
- Motor shall have to be ground connected. Or else electrified motor causes interference.
- For inverter power lower than 15kW, braking cell is also built-in. If the load inertia is moderate, it is Ok to only connect braking resistance.

**1. Power terminals sketch of inverter with 0.4~2.2KW for single-phase 230V and three-phase 230V.**



**2. Power terminals sketch of inverter with 3-phase 400V 0.4~90KW.**

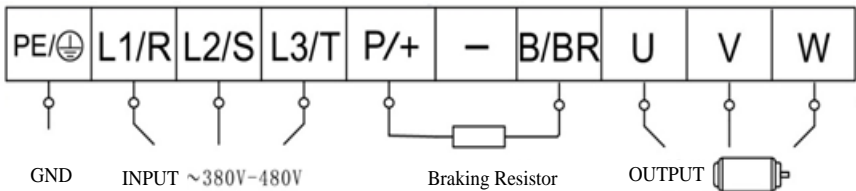

Note: power terminals L1, L2 of single-phase 230V 0.4-2.2kW are connected to 230V of power grid; (The figures are only sketch, terminals order of practical products may be different from the above-mentioned figure, it's important to be careful when connection.)

### Introduction of terminals of power loop

Terminals	Terminal Marking	Terminal Function Description
Power Input Terminal	L1/R, L2/S, L3/T	Input terminals of three-phase 400V AC voltage. Single-phase 230V is connected to L1, L2; Three-phase 220V is connected to L1, L2 and L3.
Output Terminal	U, V, W	Inverter power output terminal, connected to motor.
GND Terminal	PE/ 	Inverter grounding terminal.
Rest Terminal	P/+, B/BR	External braking resistor (Note: no terminals P or B for inverter without built-in braking unit).
	P/+, -	DC bus-line output Externally connected to braking unit P connected to input terminal "P" or "DC+" of braking unit, - connected to input terminal of braking unit "N" or "DC-".

### 3. Cable glands

#### 1) Terminal block for I1

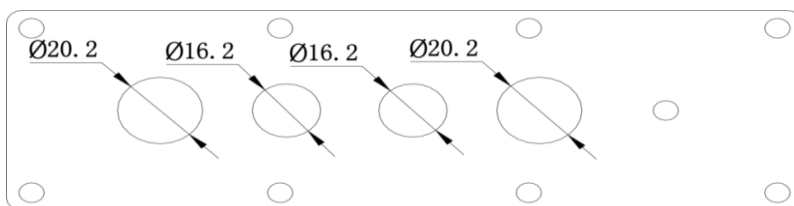

#### 2) Terminal block for I2

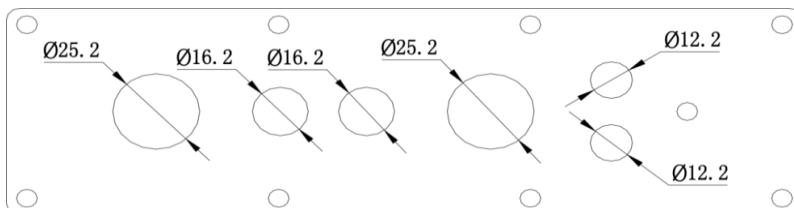

#### 3) Terminal block for I3

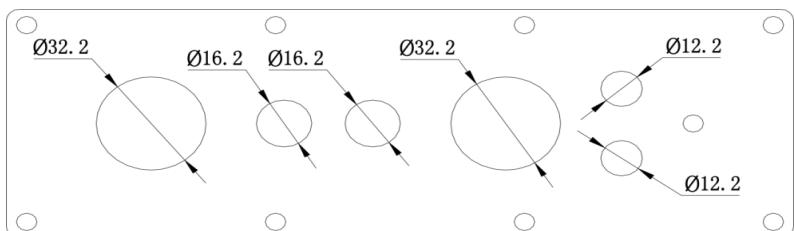

4) Terminal block for I4

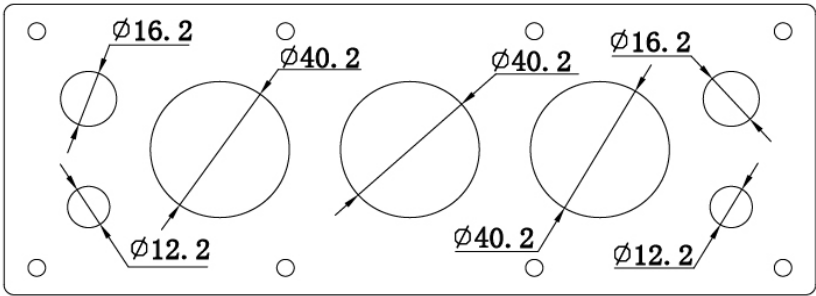

5) Terminal block for I5

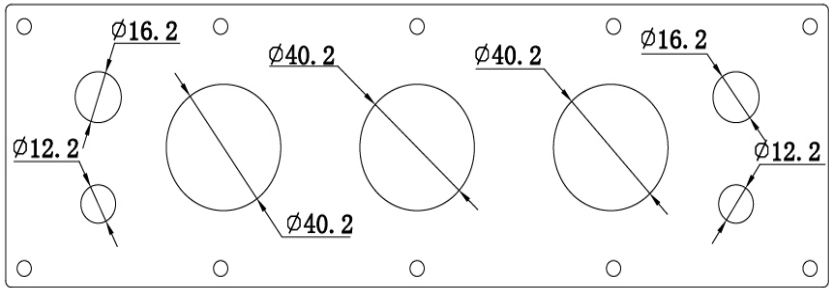

6) Terminal block for I6

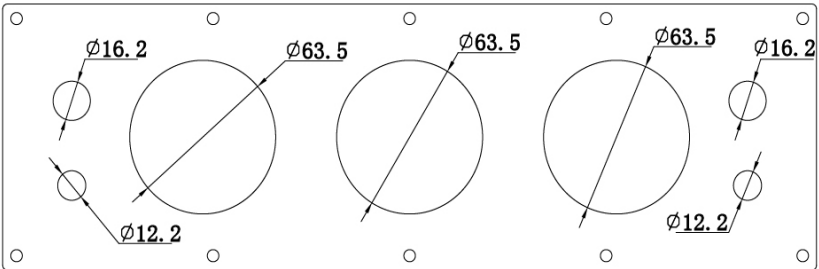



EP66 series Cable glands model selection list

EP66	M type cable glands	Cable OD(mm)	Color	Recommend model	Quantity
I1	M16×1.5	5~10	Black	M1610B	2
	M20×1.5	10~14	Black	M2014B	2
I2	M12×1.5	3~6.5	Black	M1207B	2
	M16×1.5	5~10	Black	M1610B	2
	M25×1.5	13~18	Black	M2518B	2
I3	M12×1.5	3~6.5	Black	M1207B	2
	M16×1.5	5~10	Black	M1610B	2
	M32×1.5	18~25	Black	M3225B	2
I4	M12×1.5	3~6.5	Black	M1207B	2
	M16×1.5	5~10	Black	M1610B	2
	M40×1.5	22~32	Black	M4032B	3
I5	M12×1.5	3~6.5	Black	M1207B	2
	M16×1.5	5~10	Black	M1610B	2
	M40×1.5	22~32	Black	M4032B	3
I6	M12×1.5	3~6.5	Black	M1207B	2
	M16×1.5	5~10	Black	M1610B	2
	M63×1.5	34~44	Black	M6344B	3

**3. Wiring for control loop as follows:**

1) I1-I3 structure terminals sequence for 0.4-15kW of T2, T3 and S2:

TA	TB	TC	DO1	24V	CM	DI1	DI2	DI3	DI4	DI5	DI6	10V	AI1	AI2	GND	AO1				
TA	TB	TC	DO1	DO2	24V	CM	DI1	DI2	DI3	DI4	DI5	DI6	DI7	DI8	+10V	AI1	AI2	GND	AO1	AO2
GND	+5V	A+	B-																	

2) I4-I6 structure terminals sequence for 18.5kW-90kW of T3:

**3.3 Measurement of main circuit voltages, currents and powers**

Since the voltages and currents on the inverter power supply and output sides include harmonics, measurement data depends on the instruments used and circuits measured. When instruments for commercial frequency are used for measurement, measure the following circuits with the recommended instruments.

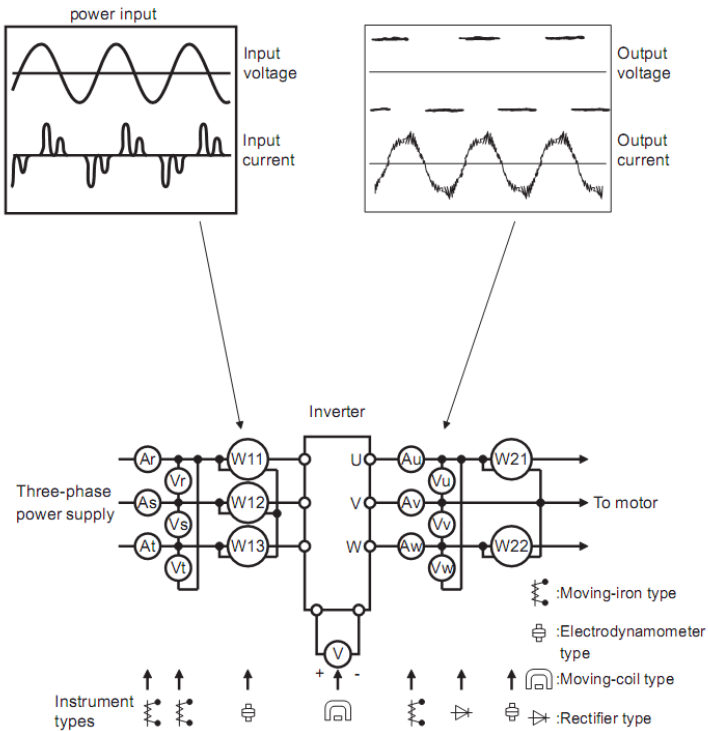

**Examples of Measuring Points and Instruments**

Item	Measuring Point	Measuring Instrument	Remarks (Reference Measurement Value)
Power supply voltage V1	Across R-S,S-T, T-R	Moving-iron type AC voltmeter	400V ±15%, 230V ±15%
Power supply side current I1	R, S, and T line currents	Moving-iron type AC voltmeter	
Power supply side power P1	At R, S and T, and across R-S, S-T and T-R	Electrodynamic type single-phase wattmeter	P1=W11+W12+W13 (3-wattmeter method)
Power supply side power factor Pf1	Calculate after measuring power supply voltage, power supply side current and power supply side power.[Three phase power supply] $Pf1 = \frac{P1}{\sqrt{3}V1 \times I1} \times 100\%$		
Output side voltage V2	Across U-V, V-W and W-U	Rectifier type AC voltmeter (Moving-iron type cannot measure)	Difference between the phases is within ±1% of the maximum output voltage.
Output side current I2	U, V and W line currents	Moving-iron type AC Ammeter	Current should be equal to or less than rated inverter current. Difference between the phases is 10% or lower of the rated inverter current.
Output side power P2	U, V, W and U-V, V-W,W-U	Electrodynamic type single-phase wattmeter	P2 = W21 + W22 2-wattmeter method
Output side power factor Pf2	Calculate in similar manner to power supply side power factor: $Pf2 = \frac{P2}{\sqrt{3}V2 \times I2} \times 100\%$		
Converter output	Across P+ (P) and -(N)	Moving-coil type (such as multi-meter)	DC voltage, the value is $\sqrt{2} \times V1$
Power supply of control PCB	Across 10V-GND	Moving-coil type (such as multi-meter)	DC10V ±0.2V
	Across 24V-CM	Moving-coil type (such as multi-meter)	DC24V ±1.5V
Analog output AO1	Across AO1-GND	Moving-coil type (such as multi-meter)	Approx. DC10V at max frequency. Approx. DC 0~20mA
Analog output AO2	Across AO2-GND	Moving-coil type (such as multi-meter)	at max frequency (4~20mA can be selected)
Alarm signal	Across TA/TC Across TB/TC	Moving-coil type (such as multi-meter)	<Normal>-<Abnormal> Across TA/TC: <Discontinuity>- <Continuity> Across TB/TC: <Continuity>- <Discontinuity>

### 3.4 Functions of control terminals

The key to operate the inverter is to operate the control terminals correctly and flexibly. Certainly, the control terminals are not operated separately, and they should match corresponding settings of parameters. This chapter describes basic functions of the control terminals. The users may operate the control terminals by combining relevant contents hereafter about “Defined Functions of the Terminals”.

**Table 4-3 Functions of Control Terminals**

Terminal	Type	Description	Function	
DO1	Output signal	Multifunctional output terminal 1	When token function enabled, the value between this terminal and CM is 0V, 24V when disabled; The max output frequency is 100KHz when high-frequency output; DO1 is high frequency output and it is not recommended to use intermediate relay.	The functions of output terminals shall be defined per manufacturer's value. Their initial state may be changed through changing function codes.
DO2		Multifunctional output terminal 2	When the token function is valid, the value between this terminal and CM is 0V; when disabled, the value is 24V.	
TA		Relay contact	TC is a common point, TB-TC are normally closed contacts, TA-TC are normally open contacts. The contact capacity of 15Kw and below 15Kw inverter is 10A/125VAC, N0/NC 3A or 250VAC/30VDC.	
TB				
TC				
AO1 <sup>note1</sup>	Analog output	Running frequency	It is connected with frequency meter, speedometer or ammeter externally, and its minus pole is connected with GND. See F423~F426 for details..	
AO2 <sup>note1</sup>		Current display	It is connected with ammeter externally, and its minus pole is connected with GND. See F427~F430 for details	
10V	Analog power supply	Self contained power supply	Internal 10V self-contained power supply of the inverter provides power to the inverter. When used externally, it can only be used as the power supply for voltage control signal, with current restricted below 20mA.	
AI1 <sup>note2</sup>	Input Signal	Voltage analog input port	When analog speed control is adopted, the voltage signal is inputted through this terminal. The range of voltage input is 0~10V, grounding: GND. When potentiometer speed control is adopted, this terminal is connected with center tap, earth wire to be connected to GND.	
AI2 <sup>note2</sup>		Voltage / Current analog input port	When analog speed control is adopted, the voltage or current signal is input through this terminal. The range of voltage input is 0~5V or 0~10V and the current input is 0~20mA, the input resistor is 500Ohm, and grounding: GND. If the input is 4~20mA, it can be realized through adjusting parameter F406. The voltage or current signal can be chosen by coding switch. See table 4-2 for details, the current channel (0-20mA) is chosen before delivery.	
24V	Power supply	Control power supply	Power: 24±1.5V, grounding is CM; current is restricted below 50mA for external use.	
CM	Common port	Grounding of control power supply	The grounding of 24V power supply and other control signals.	
DI1	Digital input control terminal	Jogging terminal	When this terminal is valid, the inverter will have jogging running. The jogging function of this terminal is valid under both at stopped and running status. This terminal can also be used as high-speed pulse input port. The max	The functions of input terminals shall be defined per manufacturer's value. Other functions can also be defined by changing

			frequency is 50K.	function codes.
DI2		External Emergency Stop	When this terminal is valid, "ESP" malfunction signal will be displayed.	
DI3		"FWD" Terminal	When this terminal is valid, inverter will run forward.	
DI4		"REV" Terminal	When this terminal is valid, inverter will run reversely.	
DI5		Reset terminal	Make this terminal valid under fault status to reset the inverter.	
DI6		Free-stop	Make this terminal valid during running can realize free stop.	
DI7 <small>note 3</small>		Running terminal	When this terminal is in the valid state, inverter will run by the acceleration time.	
DI8 <small>note 3</small>		Stop terminal	Make this terminal valid during running can realize stop by the deceleration time.	
GND	Analog grounding	Self-contained Power supply Ground	Ground terminal of external control signal (voltage control signal or current source control signal) is also the ground of 10V power supply of this inverter.	
+5V	Power	Self-contained power	Grounding for digital signal	
A+	485 communication terminals	Positive polarity of differential signal	Standard: TIA/EIA-485(RS-485) Communication protocol: Modbus	
B-		Negative polarity of Differential signal	Communication rate: 1200/2400/4800/9600/19200/38400/57600bps	

**Note:**

1. AO1 can output voltage and current signal, and AI2 can only output current.
2. AI1 can only accept voltage signal, AI2 can only accept voltage signal and current signal.
3. 15 kW and below 15 kW inverters have no DO2, AO2, DI7 and DI8 terminals.

**Wiring for digital input terminals:**

Generally, shield cable is adopted and wiring distance should be as short as possible. When active signal is adopted, it is necessary to take filter measures to prevent power supply interference. Mode of contact control is recommended.

Digital input terminals are only connected by source electrode (NPN mode) or by drain electrode (PNP mode). If NPN mode is adopted, please turn the toggle switch to the end of "NPN".

Wiring for control terminals as follows:

1. Wiring for positive source electrode (NPN mode).

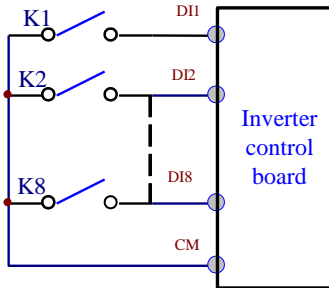

2. Wiring for active source electrode(NPN mode)

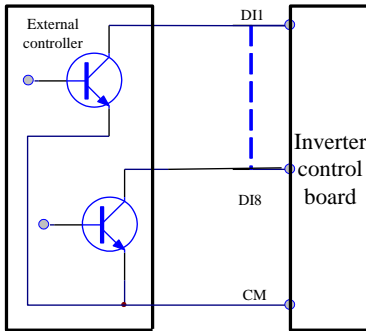

If digital input control terminals are connected by drain electrode, please turn the toggle switch to the end of “PNP”. Wiring for control terminals as follows:

3. Wiring for positive drain electrode (PNP mode)

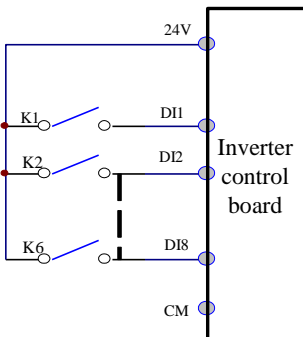

#### 4. Wiring for active drain electrode (PNP mode)

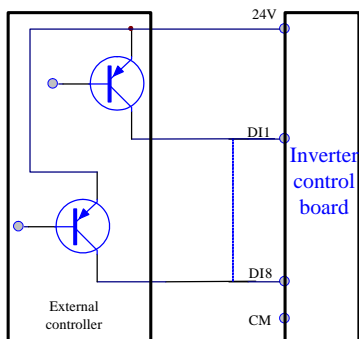

Wiring by source electrode is a mode most in use at present. Wiring for control terminal is connected by source electrode, user should choose wiring mode according to requirement.

**Instructions of choosing NPN mode or PNP mode:**

1. There is a toggle switch J7 near to control terminals. Please refer to Fig 3-2.

2. When turning J7 to “NPN”, DI terminal is connected to CM.

When turning J7 to “PNP”, DI terminal is connected to 24V.



Fig 3-2 Toggle Switch J7

### 3.5 Wiring Recommended

Inverter Model	Lead Section Area(mm <sup>2</sup> )	Inverter Model	Lead Section Area(mm <sup>2</sup> )
EP66-0004S2I1	1.5	EP66-0040T3I1	2.5
EP66-0007S2I1	2.5	EP66-0055T3I2	4.0
EP66-0015S2I1	2.5	EP66-0075T3I2	4.0
EP66-0022S2I1	4.0	EP66-0110T3I3	6.0
EP66-0004T2I1	1.5	EP66-0150T3I3	10
EP66-0007T2I1	2.5	EP66-0185T3I4	16
EP66-0015T2I1	2.5	EP66-0220T3I4	16
EP66-0022T2I1	4.0	EP66-0300T3I4	25
EP66-0004T3I1	1.5	EP66-0370T3I5	25
EP66-0007T3I1	1.5	EP66-0450T3I5	35
EP66-0015T3I1	2.5	EP66-0550T3I5	35
EP66-0022T3I1	2.5	EP66-0750T3I6	50
EP66-0030T3I1	2.5	EP66-0900T3I6	70

**3.6 Lead section area of protect conductor (grounding wire)**

Lead section area $S$ of U, V, W ( $\text{mm}^2$ )	Minimum lead section area $S$ of E ( $\text{mm}^2$ )
$S \leq 16$	$S$
$16 < S \leq 35$	16
$35 < S$	$S/2$



### 3.7 Overall Connection and “Three-Line” Connection

\* Refer to next figure for overall connection sketch for EP66 series inverters. Wiring mode is available for various terminals whereas not every terminal needs connection when applied.

Note:

1. Please only connect power terminals L1 and L2 with power grid for single-phase inverters.
2. Remote-control panels are connected with 8 core telephone wire. 485 communication port is on the control

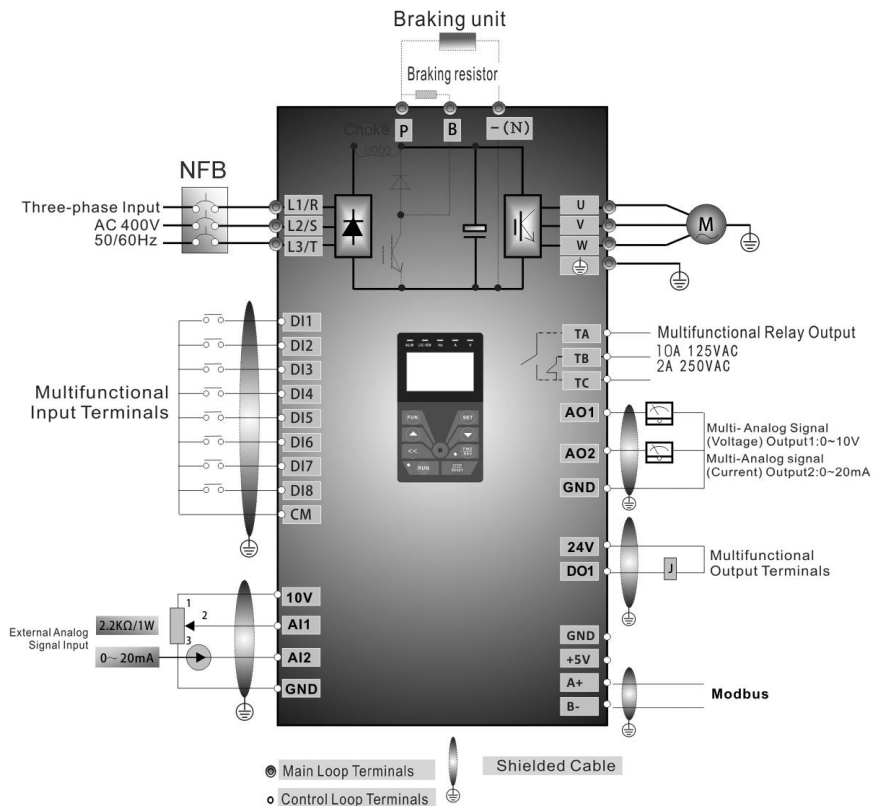

Basic Wiring Diagram for Three-phase AC drives (NPN type)

terminals.

3. 485 communication port has built-in standard MODBUS communication protocol. The terminal sequence is GND, +5V, A+, B-.
4. Inverter( $\leq 15\text{kW}$ ) has 6 multifunctional input terminals DI1~DI6.
5. The contact capacity of inverter is 10A/125VAC, NO/NC: 3A 250VAC/30VDC.

### 3.8 Basic methods of suppressing the noise

The noise generated by the drive may disturb the equipment nearby. The degree of disturbance is dependent on the drive system, immunity of the equipment, wiring, installation clearance and earthing methods.

#### 3.8.1 Noise propagation paths and suppressing methods

##### ① Noise categories

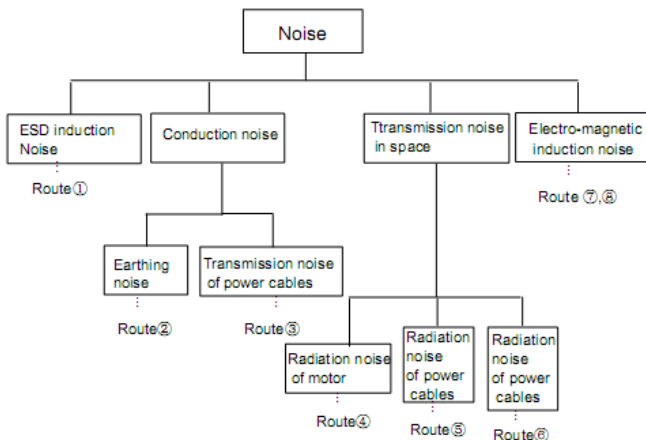

##### ② Noise propagation paths

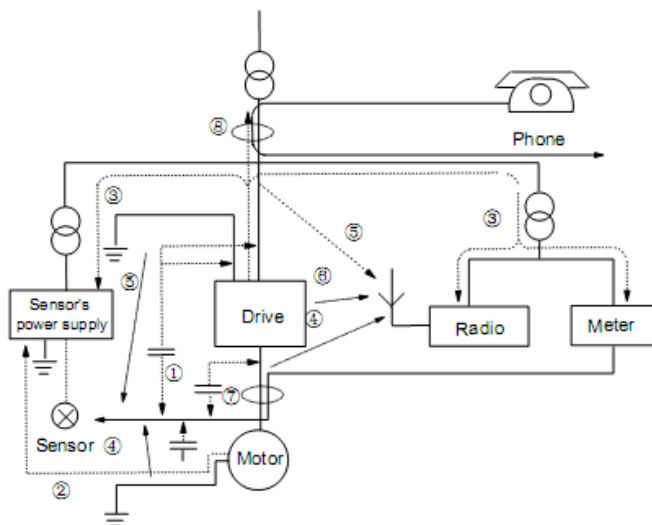

## ③ Basic methods of suppressing the noise

Noise emission paths	Actions to reduce the noise
②	When the external equipment forms a loop with the drive, the equipment may suffer nuisance tripping due to the drive's earth leakage current. The problem can be solved if the equipment is not grounded.
③	If the external equipment shares the same AC supply with the drive, the drive's noise may be transmitted along its input power supply cables, which may cause nuisance tripping to other external equipment. Take the following actions to solve this problem: Install noise filter at the input side of the drive, and use an isolation transformer or line filter to prevent the noise from disturbing the external equipment.
④⑤⑥	If the signal cables of measuring meters, radio equipment and sensors are installed in a cabinet together with the drive, these equipment cables will be easily disturbed. Take the actions below to solve the problem: (1) The equipment and the signal cables should be as far away as possible from the drive. The signal cables should be shielded and the shielding layer should be grounded. The signal cables should be placed inside a metal tube and should be located as far away as possible from the input/output cables of the drive. If the signal cables must cross over the power cables, they should be placed at right angle to one another. (2) Install radio noise filter and linear noise filter (ferrite common-mode choke) at the input and output of the drive to suppress the emission noise of power lines. (3) Motor cables should be placed in a tube thicker than 2mm or buried in a cement conduit. Power cables should be placed inside a metal tube and be grounded by shielding layer
①⑦⑧	Don't route the signal cables in parallel with the power cables or bundle these cables together because the induced electro-magnetic noise and induced ESD noise may disturb the signal cables. Other equipment should also be located as far away as possible from the drive. The signal cables should be placed inside a metal tube and should be placed as far away as possible from the input/output cables of the drive. The signal cables and power cables should be shielded cables. EMC interference will be further reduced if they could be placed inside metal tubes. The clearance between the metal tubes should be at least 20cm.

### 3.8.2 Field Wire Connections

Control cables, input power cables and motor cables should be installed separately, and enough clearance should be left among the cables, especially when the cables are laid in parallel and the cable length is big. If the signal cables must go through the power cables, they should be vertical to each other.

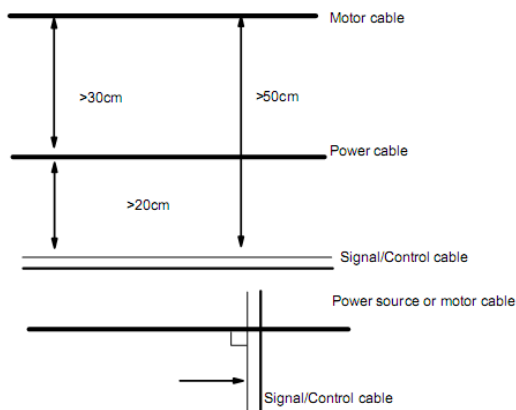

Generally, the control cables should be shielded cables and the shielding metal net must be connected to the metal enclosure of the drive by cable clamps.

### 3.8.3 Earthing

Independent earthing poles (best)

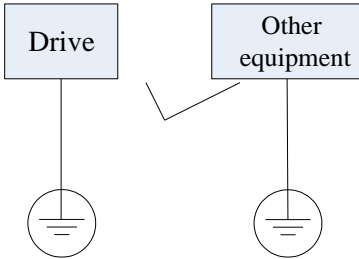

Shared earthing pole (good)

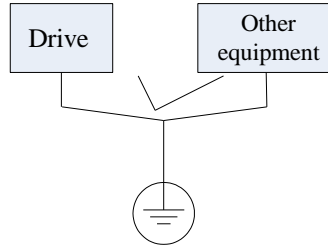

Shared earthing cable (not good)

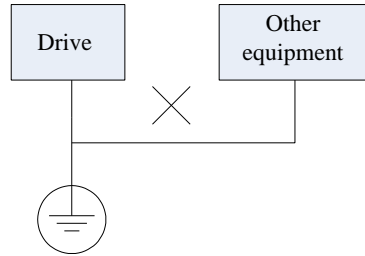
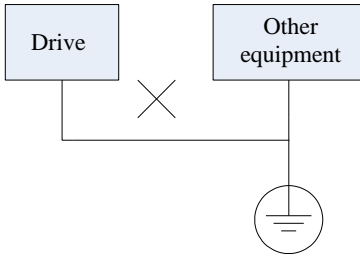

**Note:**

1. In order to reduce the earthing resistance, flat cable should be used because the high frequency impedance of flat cable is smaller than that of round cable with the same CSA.
2. If the earthing poles of different equipment in one system are connected together, then the leakage current will be a noise source that may disturb the whole system. Therefore, the drive's earthing pole should be separated with the earthing pole of other equipment such as audio equipment, sensors and PC, etc.
3. Earthing cables should be as far away from the I/O cables of the equipment that is sensitive to noise, and also should be as short as possible.

### 3.8.4 Leakage current

Leakage current may flow through the drive's input and output capacitors and the motor's capacitor. The leakage current value is dependent on the distributed capacitance and carrier wave frequency. The leakage current includes ground leakage current and the leakage current between lines.

#### Ground leakage current

The ground leakage current can not only flow into the drive system, but also other equipment via earthing cables. It may cause the leakage current circuit breaker and relays falsely activated. The higher the drive's carrier wave frequency, the bigger the leakage current, also, the longer the motor cable, the greater the leakage current,

Suppressing methods:

- Reduce the carrier wave frequency, but the motor noise may be louder;
- Motor cables should be as short as possible;
- The drive and other equipment should use leakage current circuit breaker designed for protecting the product against high-order harmonics/surge leakage current;

### Leakage current between lines

The line leakage current flowing through the distribution capacitors of the drive out side may cause the thermal relay falsely activated, especially for the drive whose power is lower than 7.5kW. When the cable is longer than 50m, the ratio of leakage current to motor rated current may be increased that can cause the wrong action of external thermal relay very easily.

Suppressing methods:

- Reduce the carrier wave frequency, but the motor noise may become louder;
- Install reactor at the output side of the drive.

In order to protect the motor reliably, it is recommended to use a temperature sensor to detect the motor's temperature, and use the drive's over-load protection device (electronic thermal relay) instead of an external thermal relay.

### 3.8.5 Electrical installation of the drive

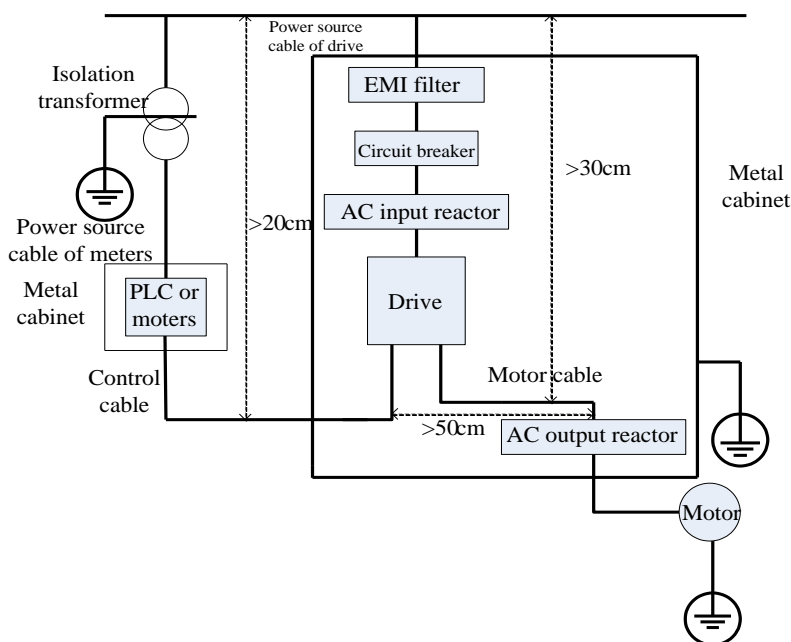

#### Note:

- Motor cable should be earthed at the drive side, if possible, the motor and drive should be earthed separately;
- Motor cable and control cable should be shielded. The shield must be earthed and avoid entangling at cable end to improve high frequency noise immunity.
- Assure good conductivity among plates, screw and metal case of the drive; use tooth-shape washer and conductive installation plate;

### 3.8.6 Application of Power Line Filter

Power source filter should be used in the equipment that may generate strong EMI or the equipment that is sensitive to the external EMI. The power source filter should be a two-way low pass filter through which only 50Hz current can flow and high frequency current should be rejected.

Function of power line filter

The power line filter ensures the equipment can satisfy the conducting emission and conducting sensitivity in EMC standard. It can also suppress the radiation of the equipment.

Common mistakes in using power cable filter

1. Too long power cable

The filter inside the cabinet should be located near to the input power source. The length of the power cables should be as short as possible.

2. The input and output cables of the AC supply filter are too close

The distance between input and output cables of the filter should be as far apart as possible, otherwise the high frequency noise may be coupled between the cables and bypass the filter. Thus, the filter will become ineffective.

3. Bad earthing of filter

The filter's enclosure must be earthed properly to the metal case of the drive. In order to be earthed well, make use of a special earthing terminal on the filter's enclosure. If you use one cable to connect the filter to the case, the earthing is useless for high frequency interference. When the frequency is high, so is the impedance of cable, hence there is little bypass effect. The filter should be mounted on the enclosure of equipment. Ensure to clear away the insulation paint between the filter case and the enclosure for good earthing contact.

### 3.8.7 Jumper Instructions of Safety Capacitors Pack

Safety capacitors and piezoresistors are integrated within inverter, the default value is effective connection status. If leakage protection switches action happens when power-on, please change the connection of safety capacitors to invalid status, detailed operation description shows as below:

The safety capacitors and piezoresistors pack: there is short-circuit jumper connected to J1 on the diver board or input safety board of inverter, its default value it that the safety capacitors and piezoresistors are in valid status, short-circuit status is J1 (1, 3) pin, which status is the solution of EMC interference; Change the connection of safety capacitors to invalid status if leakage protection switches action happens when power-on, the short-circuit status of J1 is J1 (2, 4) pin.

## IV. Operation and Simple Running

This chapter defines and interprets the terms and nouns describing the control, running and status of the inverter. Please read it carefully. It will be helpful to your correct operation.

### 4.1 Basic conception

#### 4.1.1 Control mode

EP66 inverter has three control modes: sensorless vector control (F106=0), V/F control (F106=2) and vector control 1 (F106=3), and PMSM sensorless vector control (F106=6).

#### 4.1.2 Mode of torque compensation

Under V/F control mode, EP66 inverter has four kinds of torque compensation modes: Linear compensation (F137=0); Square compensation (F137=1); User-defined multipoint compensation (F137=2); Auto torque compensation (F137=3), **VF separation (F137=4)**.

#### 4.1.3 Mode of frequency setting

Please refer to F203–F207 for the method for setting the running frequency of the EP66 inverter.

#### 4.1.4 Mode of controlling for running command

The channel for inverter to receive control commands (including start, stop and jogging, etc) contains three modes: 1. Keypad (keypad panel) control; 2. External terminal control; 3. Modbus control.

The modes of control command can be selected through the function codes F200 and F201.

#### 4.1.5 Operating status of inverter

When the inverter is powered on, it may have four kinds of operating status: stopped status, programming status, running status, and fault alarm status. They are described in the following:

##### Stopped status

If re-energize the inverter (if “auto-startup after being powered on” is not set) or decelerate the inverter to stop, the inverter is at the stopping status until receiving control command. At this moment, the running status indicator on the keypad goes off, and the display shows the display status before power down.

##### Programming status

Through keypad panel, the inverter can be switched to the status that can read or change the function code parameters. Such a status is the programming status.

There are numbers of function parameters in the inverter. By changing these parameters, the user can realize different control modes.

##### Running status

The inverter at the stopped status or fault-free status will enter running status after having received operation command.

The running indicator on keypad panel lights up under normal running status.

##### Fault alarm status

The status under which the inverter has a fault and the fault code is displayed.

Fault codes mainly include: OC, OE, OL1, OL2, OH, LU, PF1 and PF0 representing “over current”, “over voltage”, “inverter overload”, “motor overload”, “overheat”, “input under-voltage”, “input phase loss”, and “output phase loss” respectively.

For trouble shooting, please refer to Appendix I to this manual, “Trouble Shooting”.

## 4.2 Keypad panel and operation method

Keypad panel (keypad) is a standard part for configuration of EP66 inverter. Through keypad panel, the user may carry out parameter setting, status monitoring and operation control over the inverter. Both keypad panel and display screen are arranged on the keypad controller, which mainly consists of three sections: data display section, status indicating section, and keypad operating section. There are two types of keypad controller (segment LCD and four-line LCD) for inverter. For details, please refer to Chapter II of this manual, "Keypad panel".

It is necessary to know the functions and how to use the keypad panel. Please read this manual carefully before operation.

### 4.2.1 Method of operating the keypad panel

(1) Operation process of setting the parameters through keypad panel











A three-level menu structure is adopted for setting the parameters through keypad panel of inverter, which enables convenient and quick searching and changing of function code parameters.

Three-level menu: Function code group (first-level menu) → Function code (second-level menu) → Set value of each function code (third-level menu).

(2) Setting the parameters

Setting the parameters correctly is a precondition to give full play of inverter performance. The following is the introduction on how to set the parameters through keypad panel.

Operating procedures of segment LCD:

- ① Press the "Fun" key, to enter programming menu.
- ② Press  the  and  key, the function code will change within the function code group. The first number behind F displayed on the panel is 1, in other words, it displays F1××at this moment. Press  and  key, function code will change between FIXX to FCXX.
- ③ Press the key  again, the function code will change within the code group. Press  and  to change the function code to F113; press the "Set" key to display 50.00; while press  and  to change to the need frequency.
- ④ Press the "Set" key to complete the change.

### 4.2.2 Switching and displaying of status parameters

Under stopped status or running status, status parameters of the inverter can be displayed. Actual parameters displayed can be selected and set through function codes F131 and F132. Through the  key, it can switch over repeatedly and display the parameters of stopped status or running status. The followings are the description of operation method of displaying the parameters under stopped status and running status.

(1) Switching of the parameters displayed under stopped status

Under stopped status, inverter has five parameters of stopped status, which can be switched over repeatedly and displayed with the keys "Fun". These parameters are displaying: keypad jogging, target rotary speed, PN voltage, PID feedback value, and temperature. Please refer to the description of function code F132.

(2) Switching of the parameters displayed under running status

Under running status, eight parameters of running status can be switched over repeatedly and displayed with the keys "Fun". These parameters are displayed: output rotary speed, output current, output voltage, PN voltage, PID feedback value, temperature, count value and linear speed. Please refer to the description of function code F131.



### 4.2.3 Operation process of measuring motor parameters

The user shall input the parameters accurately as indicated on the nameplate of the motor prior to selecting operation mode of vector control and auto torque compensation (F137=3) of V/F control mode. Inverter will match standard motor stator resistance parameters according to these parameters indicated on the nameplate. To achieve better control performance, the user may start the inverter to measure the motor stator resistance parameters, so as to obtain accurate parameters of the motor controlled.

The motor parameters can be tuned through function code F800.

For example: If the parameters indicated on the nameplate of the motor controlled are as follows: numbers of motor poles are 4; rated power is 7.5kW; rated voltage is 400V; rated current is 15.4A; rated frequency is 50.00HZ; and rated rotary speed is 1440rpm, operation process of measuring the parameters shall be done as described in the following:

1. In accordance with the above motor parameters, set the values of F801 to F805 correctly: set the value of F801 = 7.5, F802 = 400, F803 = 15.4, F804 = 4 and F805 = 1440 respectively.
2. In order to ensure dynamic control performance of the inverter, set F800=1, i.e. select rotating tuning. Make sure that the motor is disconnected from the load. Press the "Run" key on the keypad, and the inverter will display "TEST", and it will tune the motor's parameters of two stages. After that, the motor will accelerate according to the acceleration time set at F114 and maintain for a certain period. The speed of motor will then decelerate to 0 according to the time set at F115. After auto-checking is completed, relevant parameters of the motor will be stored in function codes F806~F809, and F800 will turn to 0 automatically.
3. If it is impossible to disconnect the motor from the load, select F800=2, i.e. stationary tuning. Press the "Run" key, the inverter will display "TEST", and it will tune the motor's parameters of two stages. The motor's stator resistance, rotor resistance and leakage inductance will be stored in F806-F808 automatically, and F800 will turn to 0 automatically. The user may also calculate and input the motor's mutual inductance value manually according to actual conditions of the motor.

### 4.2.4 Operation process of simple running

**Table 4-1 Brief Introduction to Inverter Operation Process**

Process	Operation	Reference
Installation and operation environment	Install the inverter at a location meeting the technical specifications and requirements of the product. Mainly take into consideration the environment conditions (temperature, humidity, etc) and heat radiation of the inverter, to check whether they can satisfy the requirements.	See Chapters I, II, III.
Wiring of the inverter	Wiring of input and output terminals of the main circuit; wiring of grounding; wiring of switching value control terminal, analog terminal and communication interface, etc.	See Chapter III.
Checking before getting energized	Make sure that the voltage of input power supply is correct; the input power supply loop is connected with a breaker; the inverter has been grounded correctly and reliably; the power cable is connected to the power supply input terminals of inverter correctly (L1, L2 terminals for single-phase power grid, and R/L1, S/L2, and T/L3 for three-phase power grid); the output terminals U, V, and W of the inverter are connected to the motor correctly; the wiring of control terminals is correct; all the external switches are preset correctly; and the motor is under no load (the mechanical load is disconnected from the motor).	See Chapters I~III

Checking immediately after energized	Check if there is any abnormal sound, fuming or foreign flavor with the inverter. Make sure that the display of keypad panel is normal, without any fault alarm message. In case of any abnormality, switch off the power supply immediately.	See Appendix 1 and Appendix 2.
Inputting the parameters indicated on the motor's nameplate correctly, and measuring the motor's parameters.	Make sure to input the parameters indicated on the motor nameplate correctly, and study the parameters of the motor. The users shall check carefully, otherwise, serious problems may arise during running. Before initial running with vector control mode, carry out tuning of motor parameters, to obtain accurate electric parameters of the motor controlled. Before carrying out tuning of the parameters, make sure to disconnect the motor from mechanical load, to make the motor under entirely no load status. It is prohibited to measure the parameters when the motor is at a running status.	See description of parameter group F800~F830
Setting running control parameters	Set the parameters of the inverter and the motor correctly, which mainly include target frequency, upper and lower frequency limits, acceleration/deceleration time, and direction control command, etc. The user can select corresponding running control mode according to actual applications.	See description of parameter group.
Checking under no load	With the motor under no load, start the inverter with the keypad or control terminal. Check and confirm running status of the drive system. Motor's status: stable running, normal running, correct rotary direction, normal acceleration/deceleration process, free from abnormal vibration, abnormal noise and foreign flavor. Inverter's status: normal display of the data on keypad panel, normal running of the fan, normal acting sequence of the relay, free from the abnormalities like vibration or noise. In case of any abnormality, stop and check the inverter immediately.	See Chapter IV.
Checking under with load	After successful test run under no load, connect the load of drive system properly. Start the inverter with the keypad or control terminal, and increase the load gradually. When the load is increased to 50% and 100%, keep the inverter run for a period respectively, to check if the system is running normally. Carry out overall inspection over the inverter during running, to check if there is any abnormality. In case of any abnormality, stop and check the inverter immediately.	
Checking during running	Check if the motor is running stably, if the rotary direction of the motor is correct, if there is any abnormal vibration or noise when the motor is running, if the acceleration/deceleration process of the motor is stable, if the output status of the inverter and the display of keypad panel is correct, if the blower fan is run normally, and if there is any abnormal vibration or noise. In case of any abnormality, stop the inverter immediately, and check it after switching off the power supply.	

### 4.3 Illustration of basic operation

Illustration of inverter basic operation: we hereafter show various basic control operation processes by taking a 7.5kW inverter that drives a 7.5kW three-phase asynchronous AC motor as an example.

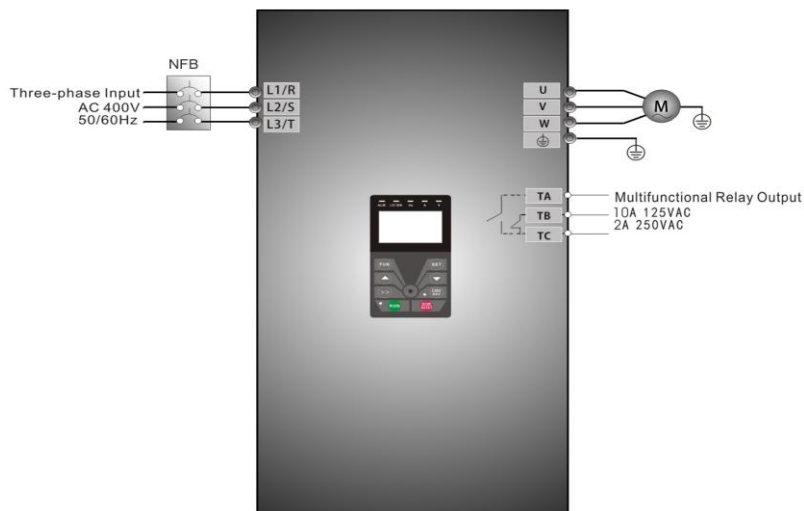

Fig 4-1 Wiring Diagram 1

The parameters indicated on the nameplate of the motor are as follows: 4 poles; rated power, 7.5kW; rated voltage, 400V; rated current, 15.4A; rated frequency 50.00HZ; and rated rotary speed, 1440rpm.

#### 4.3.1 Operation process of frequency setting, start, fwd running and stop with keypad panel

- (1) Connect the wires in accordance with Figure 4-1. After having checked the wiring successfully, switch on the air switch, and power on the inverter.
- (2) Press the “Fun” key, to enter the programming menu.
- (3) Measure the parameters of the motor

Function code	Values
F800	1(2)
F801	7.5
F802	400
F803	15.4
F805	1440

Press the “Run” key, to measure the parameters of the motor. After completion of the tuning, the motor will stop running, and relevant parameters will be stored in F806~F809. For the details of tuning of motor parameters, please refer to “Operation process of measuring the motor parameters” in this manual and Chapter XII of this manual. (Note: F800=1 is rotating tuning, F800=2 is stationary tuning. In the mode of rotating tuning, make sure to disconnect the motor from the load).

(4) Set functional parameters of the inverter:

Function code	Values
F111	50.00
F200	0
F201	0
F202	0
F203	0

(5) Press the “Run” key, to start the inverter;

(6) During running, current frequency of the inverter can be changed by pressing ▲ or ▼;

(7) Press the “Stop/Reset” key once, the motor will decelerate until it stops running;

(8) Switch off the air switch, and power off the inverter.

### 4.3.2 Operation process of setting the frequency with keypad panel, and starting, forward and reverse running, and stopping inverter through control terminals

(1) Connect the wires in accordance with Figure 4-2. After having checked the wiring successfully, switch on the air switch, and power on the inverter;

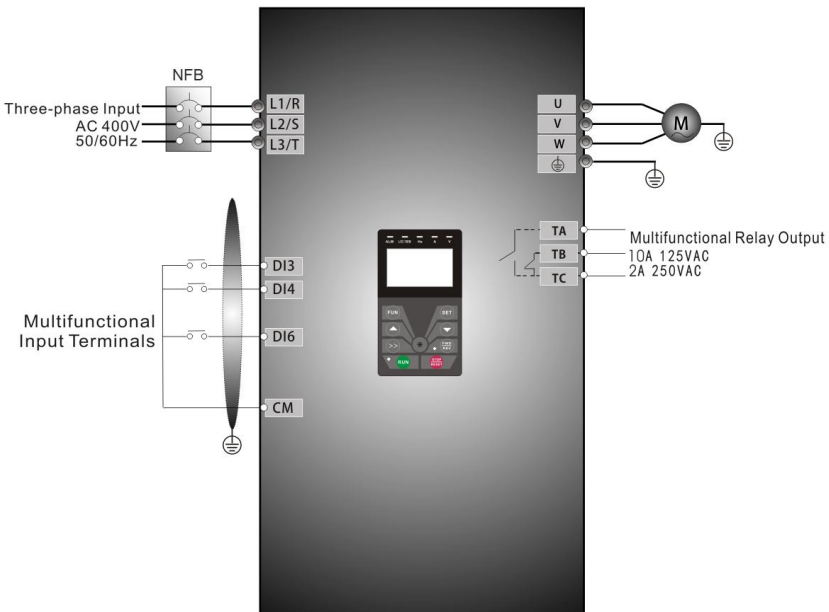

Fig 4-2 Wiring Diagram 2

(2) Press the “Fun” key, to enter the programming menu.

(3) Study the parameters of the motor: the operation process is the same as that of example 1.

(4) Set functional parameters of the inverter:

Function code	Values
F111	50.00
F203	0
F208	1

- (5) Close the switch DI3, the inverter starts forward running;
- (6) During running, current frequency of the inverter can be changed by pressing ▲ or ▼;
- (7) During running, switch off the switch DI3, then close the switch DI4, the running direction of the motor will be changed (Note: The user should set the dead time of forward and reverse running F120 on the basis of the load. If it was too short, OC protection of the inverter may occur.)
- (8) Switch off the switches DI3 and DI4, the motor will decelerate until it stops running;
- (9) Switch off the air switch, and power off the inverter.

### 4.3.3 Operation process of jogging operation with keypad panel

- (1) Connect the wires in accordance with Figure 4-1. After having checked the wiring successfully, switch on the air switch, and power on the inverter;
- (2) Press the “Fun” key, to enter the programming menu.
- (3) Study the parameters of the motor: the operation process is the same as that of example 1.
- (4) Set functional parameters of the inverter:

Function code	Values
F124	5.00
F125	30
F126	30
F132	1

- (5) Press and hold the “Run” key until the motor is accelerated to the jogging frequency, and maintain the status of jogging operation.
- (6) Release the “Run” key. The motor will decelerate until jogging operation is stopped;
- (7) Reverse jogging when F643=2.
- (8) Switch off the air switch, and power off the inverter.

### 4.3.4 Operation process of setting the frequency with analog terminal and controlling the operation with control terminals

- (1) Connect the wires in accordance with Figure 4-3. After having checked the wiring successfully, switch on the air switch, and power on the inverter. Note: 2K~5K potentiometer may be adopted for setting external analog signals. For the cases with higher requirements for precision, please adopt precise multiturn potentiometer, and adopt shielded wire for the wire connection, with near end of the shielding layer grounded reliably.

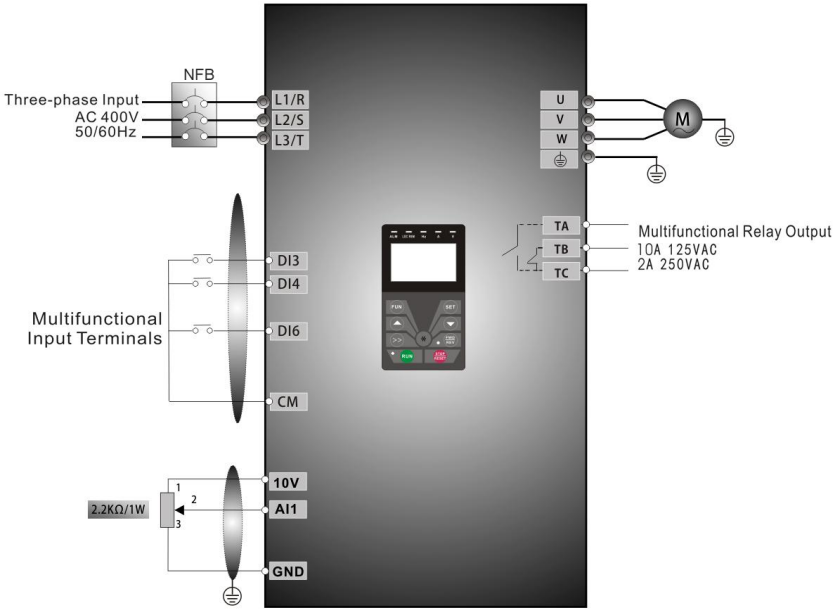

Fig 4-3 Wiring Diagram 3

- (2) Press the “Fun” key, to enter the programming menu.
- (3) Study the parameters of the motor: the operation process is the same as that of example 1.
- (4) Set functional parameters of the inverter:

Function code	Values
F203	1
F208	1

- (5) There is a red two-digit coding switch SW1 near the control terminal block of 15 kW inverter and below 15kW, as shown in Figure 4-4. The function of coding switch is to select the voltage signal (0~5V/0~10V) or current signal of analog input terminal AI2, current channel is default. In actual application, select the analog input channel through F203. Turn switches 1 to ON and 2 to ON as illustrated in the figure, and select 0~20mA current speed control. Another switches states and mode of control speed are as table 4-2.
- (6) There is a red four-digit coding switch SW1 near the control terminal block of 18.5kw and above 18.5 kW inverter, as shown in Figure 4-5. The function of coding switch is to select the input range (0~5V/0~10V/0~20mA) of analog input terminal AI1 and AI2. In actual application, select the analog input channel through F203, and select current signal or voltage signal by F438 and F439. AI1 channel default value is 0~10V, AI2 channel default value is 0~20mA. Another switches states and mode of control speed are as table 4-3
- (7) There is a toggle switch S1 at the side of control terminals, please refer to Fig 4-6. S1 is used to select the voltage input range of AI1 channel. When turning S1 to “+”, the input range is 0~10V, when turning S1 to “-”, the input range is -10~10V.
- (8) Close the switch DI3, the motor starts forward running;
- (9) The potentiometer can be adjusted and set during running, and the current setting frequency of the

inverter can be changed;

(10) During running process, switch off the switch DI3, then, close DI4, the running direction of the motor will be changed;

(11) Switch off the switches DI3 and DI4, the motor will decelerate until it stops running;

(12) Switch off the air switch, and power off the inverter.

(13) AO2 terminal can only output current signal, AO1 terminal can output voltage and current signal, the selecting switch is J5, please refer to Fig 4-7, the output relation is shown in table 4-4.



SW1

Fig 4-4

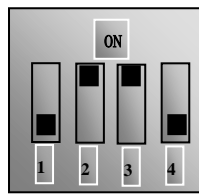

SW1

Fig 4-5



S1

Fig 4-6

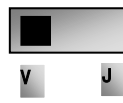

J5

Fig 4-7

**Table 4-2 the Setting of Coding Switch and Parameters in the Mode of Analog Speed Control**

F203=1, channel AI1 is selected	
S1 toggle switch	
+	-
0~10V voltage	-10~10V voltage

F203=2, channel AI2 is selected			
Function code	SW1 coding switch		
F439	Coding Switch 1	Coding Switch 2	Signal range
0	OFF	OFF	0~5V voltage
0	OFF	ON	0~10V voltage
1	ON	OFF	0~20mA current

**Table 4-3 the Setting of Coding Switch and Parameters in the Mode of Analog Speed Control**

Set F203 to 1, to select channel AI1				
Function code	SW1 coding switch		Toggle switch S1	Signal range
F438	Coding Switch 1	Coding Switch 3		
0	OFF	OFF	+	0~5V voltage
0	OFF	ON	+	0~10V voltage
1	ON	OFF	+	0~20mA current
Reserved	OFF	OFF	-	Reserved
0	OFF	ON	-	-10~10V voltage
Reserved	ON	ON	-	Reserved
ON refers to switching the coding switch to the top, OFF refers to switching the coding switch to the bottom				

Set F203 to 2, to select channel AI2			
Function code	SW1 coding switch		
F439	Coding Switch 2	Coding Switch 4	Signal range
0	OFF	OFF	0~5V voltage
0	OFF	ON	0~10V voltage
1	ON	OFF	0~20mA current

ON refers to switching the coding switch to the top, OFF refers to switching the coding switch to the bottom

**Table 4-4 the relationship between AO1 and J5 and F423**

AO1 output		The Setting of F423		
		0	1	2
J5	V	0~5V	0~10V	Reserved
	I	Reserved	0~20mA	4~20mA



## V. Function Parameters

### 5.1 Basic parameters

F100	User's Password	Setting range: 0~9999	Mfr's value: 8
------	-----------------	-----------------------	----------------

·When F107=1 with valid password, the user must enter correct user's password after power on or fault reset if you intend to change parameters. Otherwise, parameter setting will not be possible, and a prompt "Err1" will be displayed.

Relating function code: F107 Password valid or not F108 Setting user's password

F102	Inverter's Rated Current (A)		Mfr's value: Subject to inverter model
F103	Inverter Power (kW)		Mfr's value: Subject to inverter model

·Rated current and rated power can only be checked but cannot be modified.

F105	Software Edition No.	Setting range: 1.00~10.00	Mfr's value: Subject to inverter model
------	----------------------	---------------------------	--

Software Edition No. can only be checked but cannot be modified.

F106	Control mode	Setting range: 0:Sensorless vector control (SVC); 2: V/F; 3: Vector control 1 4~5: Reserved; 6: PMSM sensorless vector control	Mfr's value: 2
------	--------------	---	----------------

0: Sensorless vector control is suitable for the application of high-performance requirement. One inverter can only drive one motor.

2: V/F control is suitable for common requirement of control precision or one inverter drives several motors.

3: Vector control 1 is auto torque promotion, which has the same function of F137=3. While studying motor parameters, motor does not need to be disconnected with load. One inverter can only drive one motor.

6: PMSM sensorless vector control is suitable for the application of high-performance requirement. One inverter can only drive one motor. Now from 0.4kw-15kw inverters can drive PMSM.

Note:

1. It is necessary to study the parameters of motor before inverter runs in the sensorless vector control.
2. Under sensorless vector control, one inverter can only drive one motor and the power of motor should be similar to the power of inverter. Otherwise, control performance will be increased or system cannot work properly.
3. The operator may input motor parameters manually according to the motor parameters given by motor manufactures.
4. Usually, the motor will work normally by inverter's default parameters, but the inverter's best control performance will not be acquired. Therefore, in order to get the best control performance, please study the parameters of motor before inverter runs in the sensorless vector control.

F107	Password Valid or Not	Setting range: 0: invalid; 1:valid	Mfr's value: 0
F108	Setting User's Password	Setting range: 0~9999	Mfr's value: 8

When F107 is set to 0, the function codes can be changed without inputting the password.

When F107 is set to 1, the function codes can be changed only after inputting the user's password by F100.

User's Password can be changed by F108, same as the operation process of changing other parameters.

· Input the value of F108 into F100, and the user's password can be unlocked.

Note: When password protection is valid, and if the user's password is not entered, F108 will display 0.

F109	Starting Frequency (Hz)	Setting range: 0.00~10.00	Mfr's value: 0.00
F110	Holding Time of Starting Frequency (S)	Setting range: 0.0~999.9	Mfr's value: 0.0

The inverter begins to run from the starting frequency. If the target frequency is lower than starting frequency, F109 is invalid.

The inverter begins to run from the starting frequency. After it keeps running at the starting frequency for the time as set in F110, it will accelerate to target frequency. The holding time is not included in acceleration/deceleration time.

Starting frequency is not limited by the Min frequency set by F112. If the starting frequency set by F109 is lower than Min frequency set by F112, inverter will start according to the setting parameters set by F109 and F110. After inverter starts and runs normally, the frequency will be limited by frequency set by F111 and F112.

Starting frequency should be lower than Max frequency set by F111.

Note: when speed track is adopted, F109 and F110 are invalid.

F111	Max Frequency (Hz)	Setting range: F113~650.0	Mfr's value: 50.00
F112	Min Frequency (Hz)	Setting range: 0.00~F113	Mfr's value: 0.50

·Max frequency is set by F111.

Note: in SVC mode (F106=0), the max frequency should be lower than 150Hz.

·Min frequency is set by F112.

·The setting value of min frequency should be lower than target frequency set by F113.

·The inverter begins to run from the starting frequency. During inverter running, if the given frequency is lower than min frequency, then inverter will run at min frequency until inverter stops or given frequency is higher than min frequency.

·Max/Min frequency should be set according to the nameplate parameters and running situations of motor. The motor is forbidden running at low frequency for a long time, or else motor will be damaged because of overheat.

F113	Target Frequency (Hz)	Setting range: F112~F111	Mfr's value: 50.00
------	-----------------------	--------------------------	--------------------

It shows the preset frequency. The value is the Mfr's value of the target frequency when setting the main frequency source as "digital setting". Under keypad speed control or terminal speed control mode, the inverter will run to this frequency automatically after startup.

E.g. Remain the factory defaults unchanged after power on, then press "RUN" key on keypad, so the inverter will run from 0Hz to 50Hz(default value of target frequency).

F114	First Acceleration Time (S)	Setting range: 0.1~3000	Mfr's value: subject to inverter model
F115	First Deceleration Time (S)		
F116	Second Acceleration Time (S)		
F117	Second Deceleration Time (S)		

·F119 is used to set the reference of setting accel/deccl time.

·The Acceleration/Deceleration time can be chosen by multifunction digital input terminals F316~F321 and connecting DI terminal with CM terminal. Please refer to the instructions of multi-functional input terminals.

Note: when speed track is working, acceleration/deceleration time, min frequency and target frequency are invalid.

After speed track is finished, inverter will run to target frequency according to acceleration/deceleration time.

F118	Turnover Frequency (Hz)	Setting range: 15.00~650.0	Mfr's value: 50.00Hz
------	-------------------------	----------------------------	----------------------

·Turnover frequency is the final frequency of V/F curve, and also is the least frequency according to the highest output voltage.

·When running frequency is lower than this value, inverter has constant-torque output. When running frequency exceeds this value, inverter has constant-power output.

Note: during the process of speed track, turnover frequency is invalid. After speed track is finished, this function code is valid.

F119 The reference of setting accel/decel time	Setting range: 0: 0~50.00Hz 1: 0~max frequency	Mfr's value: 0
--	---	----------------

When F119=0, acceleration/ deceleration time means the time for inverter to accelerate/ decelerate from 0Hz (50Hz) to 50Hz (0Hz).

When F119=1, acceleration/ deceleration time means the time for inverter to accelerate/ decelerate from 0Hz (max frequency) to max frequency (0Hz).

F120 Forward / Reverse Switchover dead-Time (S)	Setting range: 0.0~3000	Mfr's value: 0.0
---	-------------------------	------------------

·Within “forward/ reverse switchover dead-time”, this latency time will be cancelled and the inverter will switch to run in the other direction immediately upon receiving “stop” signal. This function is suitable for all the speed control modes except automatic cycle operation.

·This function can ease the current impact in the process of direction switchover.

Note: during the process of speed track, F120 is invalid. After speed track is finished, this function code is valid.

F122 Reverse Running Forbidden	Setting range: 0: invalid; 1: valid	Mfr's value: 0
--------------------------------	-------------------------------------	----------------

When F122=1, inverter will only run forward no matter the state of terminals and the parameters set by F202. Inverter will not run reverse and forward / reverse switchover is forbidden. If reverse signal is given, inverter will stop.

If reverse running locking is valid (F202=1), whatever speed track is valid or not, inverter has no output.

When F122=1, F613=1, F614≥2 and inverter gets forward running command and motor is sliding reverse, if inverter can detect the sliding direction and track to motor speed, then inverter will run to 0.0Hz reverse, then run forward according to the setting value of parameters.

F123 Minus frequency is valid in the mode of combined speed control.	0: Invalid; 1: valid	0
--	----------------------	---

In the mode of combined speed control, if running frequency is minus and F123=0, inverter will run at 0Hz; if F123=1, inverter will run reverse at this frequency. (This function is controlled by F122.)

F124 Jogging Frequency (Hz)	Setting range: F112~F111	Mfr's value: 5.00Hz
F125 Jogging Acceleration Time (S)	Setting range: 0.1~3000	Mfr's value: subject to inverter model
F126 Jogging Deceleration Time (S)		

There are two types of jogging: keypad jogging and terminal jogging. Keypad jogging is valid only under stopped status

Carry out jogging operation through the keypad (under stopped status):

- When F643=1, press  \* key, inverter will run forward.
- When F643=2, press  \* key, inverter will run reverse.

Jogging Acceleration Time: the time for inverter to accelerate from 0Hz to 50Hz.

Jogging Deceleration Time: the time for inverter to decelerate from 50Hz to 0Hz.

·In case of terminal jogging, make “jogging” terminal (such as DI1) connected to CM, and inverter will run to jogging frequency. The rated function codes are from F316 to F321.

Note: when jogging function is valid, speed track function is invalid.

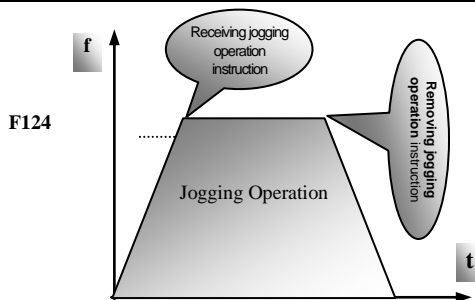

Figure 5-1 Jogging Operation

F127/F129	Skip Frequency A,B (Hz)	Setting range: 0.00~650.0	Mfr's value:0.00
F128/F130	Skip Width A,B (Hz)	Setting range: 0~2.50	Mfr's value: 0.00

·Systematic vibration may occur when the motor is running at a certain frequency. This parameter is set to skip this frequency.

The inverter will skip the point automatically when output frequency is equal to the set value of this parameter.

“Skip Width” is the span from the upper to the lower limits around Skip Frequency. For example, Skip Frequency=20Hz, Skip Width=±0.5Hz, inverter will skip automatically when output is between 19.5~20.5Hz.

Inverter will not skip this frequency span during acceleration/deceleration.

Note: during the process of speed track, skip frequency function is invalid. After speed track is finished, this function is valid.

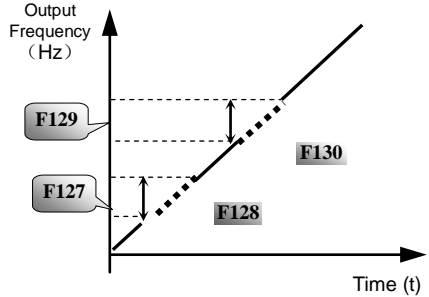

**Figure 5-2 Skip Frequency**

F131	Running Display Items	0—Current output frequency/function-code	Mfr's value: 0+1+2+4+8=15
		1—Output rotary speed 2—Output current 4—Output voltage 8—PN voltage 16—PID feedback value 32—Temperature 64—Count values 128—Linear speed 256—PID given value 2048—Output power 4096— Output torque	

Selection of one value from 1, 2, 4, 8, 16, 32, 64 and 128 shows that only one specific display item is selected. Should multiple display items be intended, add the values of the corresponding display items and take the total values as the set value of F131, e.g., just set F131 to be 19 (1+2+16) if you want to call “current output rotary speed”, “output current” and “PID feedback value”. The other display items will be covered.

As F131=8191, all display items are visible, of which, “frequency/function-code” will be visible whether or not it is selected.

Should you intend to check any display item for segment LCD, just press the “Fun” key for switchover. Should you intend to check any display item for four-line LCD, press “Fun” key and press << key to check them.

Refer to the following table for each specific value unit and its indication:

Whatever the value of F131 is set to, corresponding target frequency will flash under stopped status.

The units and representing methods for each physical quantity are displayed as below:

Target rotary speed is an integral number. If it exceeds 9999, add a decimal point to it.

Current display A \*.\* Voltage display U\*\*\* Count value \*\*\*\* Temperature H\*\*\*

Linear speed L\*\*\*

If it exceeds 999, add a decimal point to it. If it exceeds 9999, add two decimal points to it, and the like.

PID given value o\*.\* PID feedback value b\*.\* Yarn length \* center frequency \*.\*

Output power \*.\* Output torque \*.\*

Note: when count value is displayed and it exceeds 99999, only 5 digits are displayed and add a decimal point to it, i.e. 123456 is displayed in the form of 12345. .

In 4-line LCD interface, the displayed item shows alternately on the 4th line of level 3 menu in F131.

F132 Display items of stop	Setting range: 0: Frequency/function-code 2: Target rotary speed 4: PN voltage 8: PID feedback value 16: Temperature 32: Count values 64: PID given value 512: Setting torque	Mfr's value: 0+2+4=6
----------------------------	---	-------------------------

Note: The setting and displaying of F132 is the same as F131.

F133 Drive ratio of driven system	Setting range: 0.10~200.0	Mfr's value: 1.00
F134 Transmission-wheel radius	0.001~1.000 (m)	Mfr's value: 0.001

Calculation of rotary speed and linear speed:

For example, If inverter's max frequency F111=50.00Hz, numbers of motor poles F804=4, drive ratio F133 = 1.00, transmission-shaft radius R=0.05m, then

Transmission shaft perimeter:  $2\pi r = 2 \times 3.14 \times 0.05 = 0.314$  (meter)

Transmission shaft rotary speed:  $60 \times \text{operation frequency} / (\text{numbers of poles pairs} \times \text{drive ratio}) = 60 \times 50 / (2 \times 1.00) = 1500$ rpm

Endmost linear speed: rotary speed  $\times$  perimeter =  $1500 \times 0.314 = 471$  (meters/second)

F135 User's macro storage	Setting range: 0: disabled 1: Save to user's macro 1 2: Save to user's macro 2	Mfr's value: 0
---------------------------	---	----------------

F135=0, user's macro is not stored.

F135=1, save current all parameters to user's macro 1.

F135=2, save current all parameters to user's macro 2.

After storing user's macro, user can set F160=21 or F160=22 to check and recover the corresponding macro.

F136 Slip compensation	Setting range: 0~10	Mfr's value: 0
------------------------	---------------------	----------------

· Under V/F controlling, rotary speed of motor rotor will decrease as load increases. Be assured that rotor rotate speed is near to synchronization rotary speed while motor with rated load, slip compensation should be adopted according to the setting value of frequency compensation.

Note: during the process of speed track, slip compensation function is invalid. After speed track is finished, this function is valid.

F137 Modes of torque compensation	Setting range: 0: Linear compensation; 1: Square compensation; 2: User-defined multipoint compensation 3: Auto torque compensation 4: V/F separation	Mfr's value: 0
F138 Linear compensation	Setting range: 1~20	Mfr's value: subject to inverter model
F139 Square compensation	Setting range: 1: 1.5 2: 1.8 3: 1.9 4: 2.0	Mfr's value: 1

When F106=2, the function of F137 is valid.  
To compensate low-frequency torque controlled by V/F, output voltage of inverter while low-frequency should be compensated.

When F137=0, linear compensation is chosen and it is applied on universal constant-torque load;  
When F137=1, square compensation is chose and it is applied on the loads of fan or water pump;  
When F137=2, user-defined multipoint compensation is chosen and it is applied on the special loads of spin-drier or centrifuge;  
This parameter should be increased when the load is heavier, and this parameter should be decreased when the load is lighter.

If the torque is elevated too much, motor is easy to overheat, and the current of inverter will be too high. Please check the motor while elevating the torque.

When F137=3, auto torque compensation is chosen and it can compensate low-frequency torque automatically, to diminish motor slip, to make rotor rotary speed close to synchro rotary speed and to restrain motor vibration. Customers should set correctly motor power, rotary speed, numbers of motor poles, motor rated current and stator resistance. Please refer to the chapter "Operation process of measuring motor parameters".

When F137=4, output voltage is not related to output frequency, output frequency is controlled by frequency source, and output voltage is controlled by F671.

F140 Voltage compensation point frequency (Hz)	Setting range: 0~F142	Mfr's value: 1.00
F141 Voltage compensation point 1 (%)	Setting range: 0~30	Mfr's value: 0

Auxiliary torque compensation function is only valid in V/F control mode.

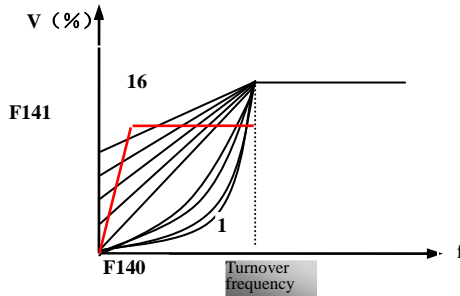

**Fig 5-3 Torque Promotion**

As shown in Fig-5-3, when F317=0, VF curve compensation =Max (F138, F141)

When F137=1, VF curve compensation =Max (F139, F141)

When F137=2, VF curve compensation =Max (Custom compensation, F141)

When F317=3, auto compensation.

Note: please do not set F141 too high; otherwise, inverter will trip into OL or OC.

F142	User-defined frequency point F2 (Hz)	Setting range: F140~F144	Mfr's value: 5.00
F143	User-defined voltage point V2 (%)	Setting range: 0~100	Mfr's value: 13
F144	User-defined frequency point F3 (Hz)	Setting range: F142~F146	Mfr's value: 10.00
F145	User-defined voltage point V3 (%)	Setting range: 0~100	Mfr's value: 24
F146	User-defined frequency point F4 (Hz)	Setting range: F144~F148	Mfr's value: 20.00
F147	User-defined voltage point V4 (%)	Setting range: 0~100	Mfr's value: 45
F148	User-defined frequency point F5 (Hz)	Setting range: F146~F150	Mfr's value: 30.00
F149	User-defined voltage point V5 (%)	Setting range: 0~100	Mfr's value: 63
F150	User-defined frequency point F6 (Hz)	Setting range: F148~F118	Mfr's value: 40.00
F151	User-defined voltage point V6 (%)	Setting range: 0~100	Mfr's value: 81

Multi-stage V/F curves are defined by 12 parameters from F140 to F151.

The setting value of V/F curve is set by motor load characteristic.

Note:  $V1 < V2 < V3 < V4 < V5 < V6$ ,  $F1 < F2 < F3 < F4 < F5 < F6$ . As low-frequency, if the setting voltage is too high, motor will overheat or be damaged. Inverter will be stalling or occur over-current protection.

During the process of speed track, polygonal-line V/F curve function is invalid. After speed track is finished, this function is valid.

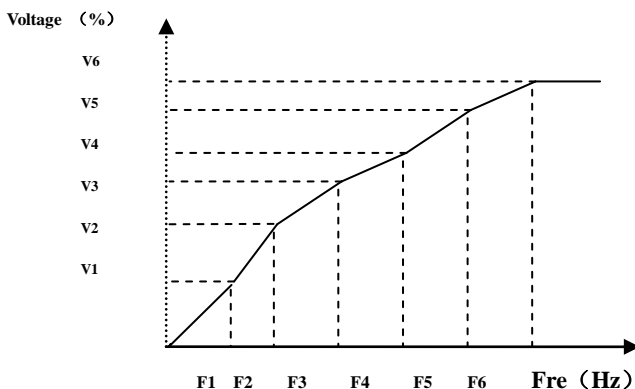

Fig 5-4 Polygonal-Line Type V/F

F152 Output voltage corresponding to turnover frequency	Setting range: 0~100	Mfr's value: 100
---	-------------------------	------------------

This function can meet the needs of some special loads, for example, when the frequency outputs 300Hz and corresponding voltage outputs 200V (supposed voltage of inverter power supply is 400V), turnover frequency F118 should be set to 300Hz and F152 is set to  $(200 \div 400) \times 100 = 50$ . And F152 should be equal to 50.

Please pay attention to nameplate parameters of motor. If the working voltage is higher than rated voltage or the frequency is higher than rated frequency, motor would be damaged.

Note: during the process of speed track, slip compensation function is invalid. After speed track is finished, this function is valid.

F153 Carrier frequency setting	Setting range: subject to inverter model	Mfr's value: subject to inverter model
--------------------------------	---	---

Carrier-wave frequency of inverter is adjusted by setting this code function. Adjusting carrier-wave may reduce motor noise, avoid point of resonance of mechanical system, decrease leakage current of wire to earth and the interference of inverter.

When carrier-wave frequency is low, although carrier-wave noise from motor will increase, the current leaked to the earth will decrease. The wastage of motor and the temperature of motor will increase, but the temperature of inverter will decrease.

When carrier-wave frequency is high, the situations are opposite, and the interference will raise.

When output frequency of inverter is adjusted to high frequency, the setting value of carrier-wave should be increased.

Performance is influenced by adjusting carrier-wave frequency as below table:

Carrier-wave frequency	Low → High
Motor noise	Loud → Low
Waveform of output current	Bad → Good
Motor temperature	High → Low
Inverter temperature	Low → High
Leakage current	Low → High
Interference	Low → High

F154 Automatic voltage rectification	Setting range: 0: Disabled 1: Enabled 2: Enabled during deceleration process	Mfr's value: 0
--------------------------------------	---	----------------

This function is enable to keep output voltage constant automatically in the case of fluctuation of input voltage, but the deceleration time will be affected by internal PI adjustor. If deceleration time is forbidden being changed, please select F154=2.

F155 Digital accessorial frequency setting (Hz)	Setting range: 0~F111	Mfr's value: 0
F156 Digital accessorial frequency polarity setting	Setting range: 0~1	Mfr's value: 0
F157 Reading accessorial frequency		
F158 Reading accessorial frequency polarity		



Set F154=1 when the rated voltage of motor is much more bigger than input voltage of inverter  
 Under combined speed control mode, when accessory frequency source is digital setting memory (F204=0), F155 and F156 are considered as initial set values of accessory frequency and polarity (direction).  
 In the mode of combined speed control, F157 and F158 are used for reading the value and direction of accessory frequency.

For example, when F203=1, F204=0. F207=1, the given analog frequency is 15Hz, inverter is required to run to 20Hz. In case of this requirement, user can push "UP" button to raise the frequency from 15Hz to 20Hz. User can also set F155=5Hz and F160=0 (0 means forward, 1 means reverse). In this way, inverter can be run to 20Hz directly.

F159 Random carrier-wave selection	Setting range: 0: Control speed normally (prohibited) 1: Random carrier-wave frequency (allowed)	Mfr's value: 0
------------------------------------	--	-------------------

When F159=0, inverter will modulate as per the carrier-wave set by F153. When F159=1, inverter will operate in mode of random carrier-wave modulating.

When random carrier-wave is selected, output torque will increase but noise will be loud. When the carrier-wave set by F153 is selected, noise will be reduced, but output torque will decrease. Please set the value according to the situation.

F160 Revert to manufacturer values	Setting range: 0: Not reverting to manufacturer values 1: Reverting to manufacturer values 10: Revert to manufacturer value for Europe 21: Revert to user macro 1 22: Revert to user macro 2	Mfr's value: 0
------------------------------------	---	----------------

When there is disorder with inverter's parameters and manufacturer values need to be restored, set F160=1. After "Reverting to manufacturer values" is done, F160 values will be automatically changed to 0.

After set F135 to store the parameter macro, user needs to set F160 to check or retrieve the stored macro parameters. F160=21, revert the current parameters to user macro 1; F160=22, revert to user macro 2.

Note: If user set F160=21 or 22 before storing user macro 1 or 2, "user macro unsaved" will display in 4-line LCD keypad; "Err 1" will display in segment LCD keypad.

"Reverting to manufacturer values" will not work for the function-codes marked "o" in the "change" column of the parameters table. These function codes have been adjusted properly before delivery. And it is recommended not to change them.

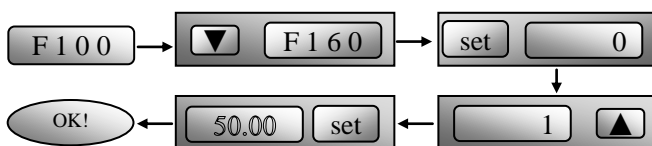

Figure 5-5 Reverting to manufacturer values

## 5.2 Operation Control

F200 Source of start command	Setting range: 0: Keypad command; 1: Terminal command; 2: Keypad+Terminal; 3: MODBUS; 4: Keypad+Terminal+MODBUS	Mfr's value: 4
F201 Source of stop command	Setting range: 0: Keypad command; 1: Terminal command; 2: Keypad+Terminal; 3: MODBUS; 4: Keypad+Terminal+MODBUS	Mfr's value: 4

·F200 and F201 are the resource of selecting inverter control commands.

·Inverter control commands include: starting, stopping, forward running, reverse running, jogging, etc.

·“Keypad command” refers to start/stop commands given by the “Run” or “stop/reset” key on the keypad.

·“Terminal command” refers to the start/stop command given by the “Run” terminal defined by F316-F321.

When F200=3 and F201=3, the running command is given by MODBUS communication.

When F200=2 and F201=2, “keypad command” and “terminal command” are valid at the mean time, F200=4 and F201=4 are the same.

F202 Mode of direction setting	Setting range: 0: Forward running locking; 1: Reverse running locking; 2: Terminal setting 3: Keypad set direction	Mfr's value: 0
--------------------------------------	--	----------------

The running direction is controlled by this function code together with other speed control mode which can set the running direction of inverter. When auto-circulation speed is selected by F500=2, this function code is not valid.

When speed control mode without controlling direction is selected, the running direction of inverter is controlled by this function code, for example, keypad controls speed.

Direction given by F202	Direction given by other control mode	Running direction	remarks
0	0	0	0 means forward.
0	1	1	
1	0	1	1 means reverse.
1	1	0	

When F202=3, during running process, the direction of inverter can only be changed by pressing FWD/REV in keypad.

<p>F203 Main frequency source X</p>	<p>Setting range: 0: Memory of digital given; 1: External analog AI1; 2: External analog AI2; 3: Pulse input given; 4: Stage speed control; 5: No memory of digital given; 7: Reserved;8:Reserved; 9: PID adjusting; 10: MODBUS</p>	<p>Mfr's value: 0</p>
---	---	-----------------------

Main frequency source is set by this function code.

#### 0: Memory of digital given

Its initial value is the value of F113. The frequency can be adjusted through the key “up” or “down”, or through the “up”, “down” terminals.

“Memory of digital given” means after inverter stops, the target frequency is the running frequency before stop. If the user would like to save target frequency in memory when the power is disconnected, please set F220=1, i.e. frequency memory after power down is valid.

#### 1: External analog AI1; 2: External analog AI2

The frequency is set by analog input terminal AI1 and AI2. The analog signal may be current signal (0-20mA or 4-20mA) or voltage signal (0-5V or 0-10V), which can be chosen by switch code. Please adjust the switch code according to practical situations, refer to fig 4-4 and table 4-2.

When inverters leave the factory, the analog signal of AI1 channel is DC voltage signal, the range of voltage is 0-10V, and the analog signal of AI2 channel is DC current signal, the range of current is 0-20 mA. If 4-20mA current signal is needed, please set lower limit of analog input F406=2, which input resistor is 500OHM. If some errors exist, please make some adjustments.

#### 3: Pulse input given

When frequency is given by pulse input, the pulse is only inputted by DI1 terminal. The max pulse frequency is 50K. The related parameters are from F440 to F446.

#### 4: Stage speed control

Multi-stage speed control is selected by setting stage speed terminals F316-F322 and function codes of multi-stage speed section. The frequency is set by multi-stage terminal or automatic cycling frequency.

#### 5: No memory of digital given

Its initial value is the value of F113. The frequency can be adjusted through the key “up” or “down”, or through the “up”, “down” terminals.

“No memory of digital given” means that the target frequency will restore to the value of F113 after stop no matter the state of F220.

#### 9: PID adjusting

When PID adjusting is selected, the running frequency of inverter is the value of frequency adjusted by PID. Please refer to instructions of PID parameters for PID given resource, PID given numbers, feedback source, and so on.

#### 10: MODBUS

The main frequency is given by MODBUS communication.

F204 Accessorial frequency source Y	Setting range: 0: Memory of digital given; 1: External analog AI1; 2: External analog AI2; 3: Pulse input given; 4: Stage speed control; 5: PID adjusting;	Mfr's value: 0
-------------------------------------	--	----------------

When accessorial frequency Y is given to channel as independent frequency, it has the same function with main frequency source X.

When F204=0, the initial value of accessorial frequency is set by F155. When accessorial frequency controls speed independently, polarity setting F156 is not valid.

When F207=1 or 3, and F204=0, the initial value of accessorial frequency is set by F155, the polarity of accessorial frequency is set by F156, the initial value of accessorial frequency and the polarity of accessorial frequency can be checked by F157 and F158.

When the accessorial frequency is given by analog input (AI1, AI2), the setting range for the accessorial frequency is set by F205 and F206.

When the accessorial frequency is given by keypad potentiometer, the main frequency can only select stage speed control and modbus control (F203=4, 10)

Note: accessorial frequency source Y or main frequency source X cannot use same frequency given channel.

F205 reference for selecting accessorial frequency source Y range	Setting range: 0: Relative to max frequency; 1: Relative to main frequency X	Mfr's value: 0
F206 Accessorial frequency Y range (%)	Setting range: 0~100	Mfr's value: 100

When combined speed control is adopted for frequency source, F206 is used to confirm the relative object of the setting range for the accessorial frequency.

F205 is to confirm the reference of the accessorial frequency range. If it is relative to main frequency, the range will change according to the change of main frequency X.

F207 Frequency source selecting	Setting range: 0: X; 1: X+Y; 2: X or Y (terminal switchover, Y is prior to X when not switchover); 3: X or X+Y (terminal switchover); 4: Combination of stage speed and analog 5: X-Y 6: $X+Y-Y_{MAX} * 50\%$ 7: Combination of stage speed and digit 1	Mfr's value: 0
---------------------------------	---	----------------

Select the channel of setting the frequency. The frequency is given by combination of main frequency X and accessorial frequency Y.

When F207=0, the frequency is set by main frequency source X.

When F207=1, X+Y, the frequency is set by adding main frequency source to accessorial frequency source. X or Y cannot be given by PID.

When F207=2, main frequency source and accessorial frequency source can be switched over by frequency source switching terminal.

When F207=3, main frequency given and adding frequency given(X+Y) can be switched over by frequency source switching terminal. X or Y cannot be given by PID.

When F207=4, stage speed setting of main frequency source has priority over analog setting of accessorial frequency source (only suitable for F203=4 F204=1).

When F207=5, X-Y, the frequency is set by subtracting accessorial frequency source from main frequency source. If the frequency is set by main frequency or accessorial frequency, PID speed control cannot be selected.

When F207=6,  $X+Y-Y_{MAX} * 50\%$ , the frequency is given by both main frequency source and accessorial frequency source. X or Y cannot be given by PID. When F205=0,  $Y_{MAX}=F111 * F206$ . When F205=1,  $Y_{MAX}=X * F206$ .

When F207=7, the stage speed of main frequency source is in preference to the given digital value of accessorial frequency resource. (Only applied to F203=4, F204=0)

**Note:**

1. When F203=4 and F204=1, the difference between F207=1 and F207=4 is that when F207=1, frequency source selecting is the addition of stage speed and analog, when F207=4, frequency source selecting is stage speed with stage speed and analog given at the same time. If stage speed given is canceled and analog given still exists, inverter will run by analog given.
2. Frequency given mode can be switched over by selecting F207. For example: switching PID adjusting and normal speed control, switching stage speed and analog given, switching PID adjusting and analog given, and so on.
3. The acceleration/deceleration time of stage speed is set by function code of corresponding stage speed time. When combined speed control is adopted for frequency source, the acceleration/deceleration time is set by F114 and F115.
4. The mode of automatic cycle speed control is unable to combine with other modes.
5. When F207=2 (main frequency source and accessorial frequency source can be switched over by terminals), if main frequency is not set to be under stage-speed control, accessorial frequency can be set to be under automatic cycle speed control (F204=5, F500=0). Through the defined switchover terminal, the control mode (defined by X) and automatic cycle speed control (defined by Y) can be freely switched.
6. If the settings of main frequency and accessorial frequency are the same, only main frequency will be valid.
7. When F207=6, F205=0 and F206=100,  $X+Y-Y_{MAX} * 50\% = X+Y-F111 * 50\%$ , and if F207=6, F205=1 and F206=100, then  $X+Y-Y_{MAX} * 50\% = X+Y-X * 50\%$ .

<p>F208 Terminal two-line/three-line operation control</p>	<p>Setting range: 0: No function 1: Two-line operation mode 1; 2: Two-line operation mode 2; 3: three-line operation mode 1; 4: three-line operation mode 2; 5: start/stop controlled by direction pulse</p>	<p>Mfr's value: 0</p>
--	--	-----------------------

- When selecting two-line type or three-line type), F200, F201 and F202 are invalid.
- Five modes are available for terminal operation control.

**Note:**

In case of stage speed control, set F208 to 0. If F208 ≠ 0 (when selecting two-line type or three-line type), F200, F201 and F202 are invalid.

“FWD”, “REV” and “X” are three terminals designated in programming DI1~DI6.

1. Two-line operation mode 1: this mode is the most popularly used two-line mode. The running direction of mode is controlled by FWD, REV terminals.

**For example: “FWD” terminal-----“open”: stop, “closed”: forward running;**

**“REV” terminal-----“open”: stop, “closed”: reverse running;**

**“CM” terminal-----common port**

K1	K2	Running command
0	0	Stop
1	0	Forward running
0	1	Reverse running
1	1	Stop

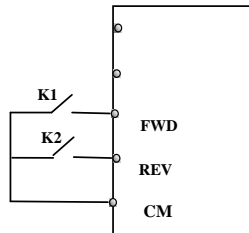

2. Two-line operation mode 2: when this mode is used, FWD is enable terminal, the direction is controlled by REV terminal.

**For example: “FWD” terminal-----“open”: stop, “closed”: running;**

**“REV” terminal-----“open”: forward running, “closed”: reverse running;**

**“CM” terminal-----common port**

K1	K2	Running command
0	0	Stop
0	1	Stop
1	0	Forward running
1	1	Reverse running

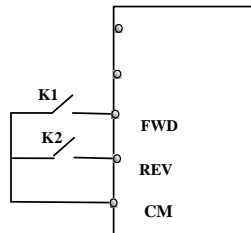

3. Three-line operation mode 1:

In this mode, X terminal is enable terminal, the direction is controlled by FWD terminal and REV terminal. Pulse signal is valid.

Stopping commands is enabled by opening X terminal.

**SB3: Stop button**

**SB2: Forward button.**

**SB1: Reverse button.**

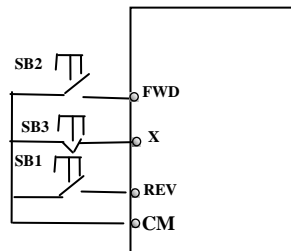

4. Three-line operation mode 2:

In this mode, X terminal is enable terminal, running command is controlled by FWD terminal. The running direction is controlled by REV terminal, and stopping command enable by opening X terminal.

**SB1: Running button**

**SB2: Stop button**

**K1: direction switch. Open stands for forward running; close stands for reverse running.**

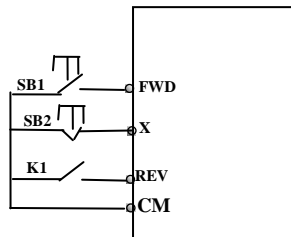

5. Start/stop controlled by direction pulse:

“FWD” terminal—(impulse signal: forward/stop)

“REV” terminal—(impulse signal: reverse/stop)

“CM” terminal—common port

Note: when pulse of SB1 triggers, inverter will run forward. When the pulse triggers again, inverter will stop running.

When pulse of SB2 triggers, inverter will run reverse. When the pulse triggers again, inverter will stop running.

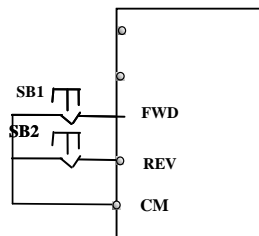

<p>F209 Selecting the mode of stopping the motor</p>	<p>Setting range: 0: stop by deceleration time; 1: free stop 2: Stop by DC braking</p>	<p>Mfr's value: 0</p>
--	--	-----------------------

When the stop signal is input, stopping mode is set by this function code:

F209=0: stop by deceleration time

Inverter will decrease output frequency according to setting acceleration/deceleration curve and decelerating time, after frequency decreases to 0, inverter will stop. This is often common stopping type. During the process of speed track, this function is invalid. And inverter will be forced to stop during this process.

F209=1: free stop

After stop command is valid, inverter will stop output. Motor will free stop by mechanical inertia.

<p>F210 Frequency display accuracy(Hz)</p>	<p>Setting range: 0.01~2.00</p>	<p>Mfr's value: 0.01</p>
--	---------------------------------	--------------------------

Under keypad speed control or terminal UP/DOWN speed control, frequency display accuracy is set by this function code and the range is from 0.01 to 2.00. For example, when F210=0.5, UP/DOWN terminal is pressed at one time, frequency will increase or decrease by 0.5Hz.

This function is valid when inverter is in the running state. When inverter is in the standby state, no matter what value of this function code is, frequency will increase or decrease by 0.01Hz.

F211 Speed of digital control	Setting range: 0.01~100.0Hz/S	Mfr's value: 5.00
-------------------------------	-------------------------------	-------------------

When UP/DOWN terminal is pressed, frequency will change at the setting rate. The Mfr's value is 5.00Hz/s. In practical application, set the value of F211 refer to the calculation of  $F114=50.00(Hz)/F114$  if request to keep consistent with reset frequency and actual running frequency by setting UP/DOWN terminals. For example,  $F114=5.0s$ ,  $F211=50.00(Hz)/5.0(s)=10(Hz/S)$

F212 Direction memory	Setting range: 0: Disabled 1: Enabled	Mfr's value: 0
-----------------------	---------------------------------------	----------------

This function is valid when three-line operation mode 1(F208=3) is valid.

When F212=0, after inverter is stopped, reset and repowered on, the running direction is not memorized.

When F212=1, after inverter is stopped, reset and repowered on, if inverter starts running but no direction signal, inverter will run according the memory direction.

F213 Auto-starting after repowered on	Setting range: 0: Disabled; 1: Enabled	Mfr's value: 0
---------------------------------------	--	----------------

F214 Auto-starting after reset	Setting range: 0: Disabled; 1: Enabled	Mfr's value: 0
--------------------------------	--	----------------

Whether or not to start automatically after repowered on is set by F213

F213=1, Auto-starting after repowered on is valid. When inverter is power off and then powered on again, it will run automatically after the time set by F215 and according to the running mode before power-down. If F220=0 frequency memory after power-down is not valid, inverter will run by the setting value of F113.

F213=0, after repower-on, inverter will not run automatically unless running command is given to inverter.

Whether or not to start automatically after fault resetting is set by F214

When F214=1, if fault occurs, inverter will reset automatically after delay time for fault reset (F217). After resetting, inverter will run automatically after the auto-starting delay time (F215).

If frequency memory after power-down (F220) is valid, inverter will run at the speed before power-down. Otherwise, inverter will run at the speed set by F113.

In case of fault under running status, inverter will reset automatically and auto-start. In case of fault under stopped status, the inverter will only reset automatically.

When F214=0, after fault occurs, inverter will display fault code, it must be reset by manually.

F215 Auto-starting delay time (S)	Setting range: 0.1~3000.0	Mfr's value: 60.0
-----------------------------------	---------------------------	-------------------

F215 is the auto-starting delay time for F213 and F214. The range is from 0.1s to 3000.0s.

F216 Times of auto-starting in case of repeated faults	Setting range: 0~5	Mfr's value: 0
F217 Delay time for fault reset (S)	Setting range: 0.0~10.0	Mfr's value: 3.0
F219 EEPROM write operation	Setting range: 0:enabled to write 1:prohibit writing	Mfr's value: 1

F216 sets the most times of auto-starting in case of repeated faults. If starting times are more than the setting value of this function code, inverter will not reset or start automatically after fault. Inverter will run after running command is given to inverter manually.

F217 sets delay time for fault reset. The range is from 0.0 to 10.0S which is time interval from fault to resetting.

When F219=1 (address 2001H is not operated by PC/PLC), the function code is modified by communication, and it is not saved in the EEPROM. It means there is no memory when power down. When F219=0 (address 2001H is not operated by PC/PLC), the function code is modified by communication, and it is saved in the EEPROM. It means there is memory when power down.

F220 Frequency memory after power-down	Setting range: 0: invalid; 1: valid	Mfr's value: 0
--	-------------------------------------	----------------

F220 sets whether or not frequency memory after power-down is valid.



This function is valid for F213 and F214. Whether or not to memory running state after power-down or malfunction is set by this function.

The function of frequency memory after power-down is valid for main frequency and accessory frequency that is given by digital. Because the digital given accessory frequency has positive polarity and negative polarity, it is saved in the function codes F155 and F156.

F222	count memory selection	Setting range: 0: Invalid 1: Valid	Mfr's value: 0
------	------------------------	------------------------------------	----------------

F220 sets whether or not count memory is valid. Whether or not to memory counting values after power-down or malfunction is set by this function.

F223	main frequency coefficient	Setting range: 0.0~100.0	Mfr's value: 100.0
------	----------------------------	--------------------------	--------------------

F223: main frequency coefficient. Target frequency=main frequency \* main frequency coefficient.

**Table 5-1** Combination of Speed Control

F203 \ F204	0. Memory of digital setting	1 External analog AI1	2 External analog AI2	3 Pulse input given	4 Terminal stage speed control	5 PID adjusting
0 Memory of Digital setting	○	●	●	●	●	●
1 External analog AI1	●	○	●	●	●	●
2 External analog AI2	●	●	○	●	●	●
3 Pulse input given	●	●	●	○	●	●
4 Terminal Stage speed control	●	●	●	●	○	●
5 Digital setting	○	●	●	●	●	●
9 PID adjusting	●	●	●	●	●	○
10 MODBUS	●	●	●	●	●	●

●: Inter-combination is allowable.

○: Combination is not allowable.

The mode of automatic cycle speed control is unable to combine with other modes. If the combination includes the mode of automatic cycle speed control, only main speed control mode will be valid.

F224	when target frequency is lower than Min frequency	Setting range: 0: stop 1: run at min frequency	Mfr's value: 0
------	---	---	----------------

F224=0, when target frequency is lower than Min frequency (F112, 0.1), inverter will stop.

F224=1, when target frequency is lower than Min frequency, inverter will run at Min frequency.

F277	Third acceleration time(S)	Setting range: 0.1~3000	Subject to inverter model
F278	Third deceleration time(S)		
F279	Fourth acceleration time(S)		
F280	Fourth deceleration time(S)		

## 5.3. Multifunctional Input and Output Terminals

### 5.3.1 Digital multifunctional output terminals

During the process of speed track, the function of F300~F312 is still valid.

F300	Relay token output	Setting range: 0~60 Refer to table 5-2 for detailed instructions.	Mfr's value: 1
F301	DO1 token output		Mfr's value: 14
F302	DO2 token output		Mfr's value: 5

EP66 inverter has one multifunctional relay output terminal. In water supply system, if the fixed mode or timing interchanging mode is selected, the values of from F300 to F301 cannot be set 30-32.

**Table 5-2 Instructions for digital multifunctional output terminal**

Value	Function	Instructions
0	no function	Output terminal has no functions.
1	inverter fault protection	When inverter works wrong, ON signal is output.
2	over latent frequency 1	Please refer to instructions from F307 to F309.
3	over latent frequency 2	Please refer to instructions from F307 to F309.
4	free stop	Under free stop status, after stop command is given, ON signal is output until inverter completely stops.
5	In running status 1	Indicating that inverter is running and ON signal is output.
6	Reserved	
7	acceleration/deceleration time switchover	Indicating that inverter is in the status of acceleration/deceleration time switchover
8	Reaching the Set Count Value	This terminal will be "action" when inverter carries the external count instruction and count value reaches the set value of F314.
9	Reaching the Designated Count Value	This terminal will be "action" when inverter carries the external count instruction and count value reaches the set value of F315.
10	inverter overload pre-alarm	After inverter overloads, ON signal is output after the half time of protection timed, ON signal stops outputting after overload stops or overload protection occurs.
11	motor overload pre-alarm	After motor overloads, ON signal is output after the half time of protection timed, ON signal stops outputting after overload stops or overload protection occurs.
12	Stalling	During accel/decel process, inverter stops accelerating/decelerating because inverter is stalling, and ON signal is output.
13	Inverter is ready to run	When inverter is powered on. Protection function is not in action and inverter is ready to run, then ON signal is output.
14	In running status 2	Indicating that inverter is running and ON signal is output. When inverter is running at 0HZ, it seems as the running status, and ON signal is output.
15	frequency arrival output	Indicating inverter runs to the setting target frequency, and ON signal is output. See F312.
16	overheat pre-alarm	When testing temperature reaches 80% of setting value, ON signal is output. When overheat protection occurs or testing value is lower than 80%of setting value, ON signal stops outputting.

17	over latent current output	When output current of inverter reaches the setting overlatent current, ON signal is output. See F310 and F311.
18	Analog line disconnection protection	Indicating inverter detects analog input lines disconnection, and ON signal is output. Please refer to F741.
19	Under-load 1 pre-alarm	Please refer to FA26 and FA27.
20	Zero current detecting output	When inverter output current has fallen to zero current detecting value, and after the setting time of F755, ON signal is output. Please refer to F754 and F755.
21	Output controlled by communication address 2005H	1 means output is valid. 0 means output is invalid.
22	Output controlled by communication address 2006H	
23	Output controlled by communication address 2007H	
24	Watchdog output token	The token output is valid when inverter trips into Err6.
25-29	Reserved	
30	General pump is running	Indicating some general pumps are running.
31	Converter pump is running	Indicating some converter pumps are running.
32	Over-limit pressure token	Indicating the max limit value when PID adjusting is valid and negative feedback is selected, and feedback pressure is higher than max pressure set by F503
33-42	Reserved	
43	Communication timeout 1	When F907>0, and receiving the previous data, if after the time set by F907, the next data is not received, inverter will output communication timeout signal. The timeout signal will be cleared by this terminal, and after receiving correct data, inverter will accumulate time again.
45	Lower than setting token temperature	Output token is valid when temperature is not higher than 0°C; Output token is invalid when temperature is higher than 0°C+2°C;
59	oPEn fault representation	When oPEn protection is enabled, representation output is valid; Otherwise, it is invalid.

F303 DO1 output type selection	Setting range: 0: switch level output 1: pulse output	Mfr's value: 0
--------------------------------	---	----------------

When level output is selected, all terminal functions in table 5-2 can be defined by F301.

When pulse output is selected, DO1 can be defined as high-speed pulse output terminal. The max pulse frequency is 50KHz. The related function codes are F449、F450、F451、F452、F453.

F304	S curve beginning stage proportion (%)	Setting range: 2.0~50.0	30.0
F305	S curve ending stage proportion (%)	Setting range: 2.0~50.0	30.0
F306	Accel/decel mode	Setting range: 0: Straight-line 1: S curve	0

Please refer to Fig 5-7 about S curve acceleration/deceleration:

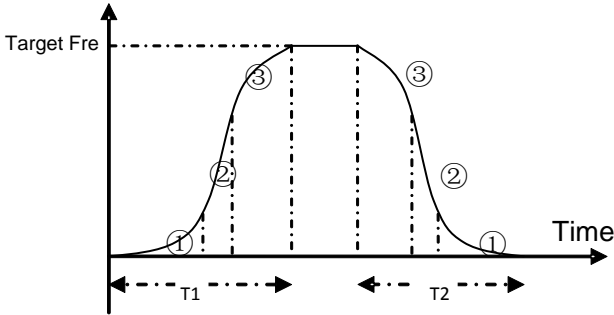

**Figure 5-6 S curve acceleration/deceleration**

T1 is the acceleration time from present frequency to target frequency.

T2 is the deceleration time from present frequency to target frequency.

During the acceleration process, in the ① stage, the acceleration slope is bigger gradually, in the ② stage, the acceleration slope is constant, in the ③ stage, the acceleration slope is weaker gradually.

F307	Characteristic frequency 1 (Hz)	Setting range: F112~F111	Mfr's value: 10
F308	Characteristic frequency 2 (Hz)		Mfr's value: 50
F309	Characteristic frequency width(%)	Setting range: 0~100%	Mfr's value: 50

When F300=2, 3, F301=2, 3 and F302=2, 3 and token characteristic frequency is selected, this group function codes set characteristic frequency and its width. For example: setting F301=2, F307=10, F309=10, when frequency is higher than F307, DO1 outputs ON signal. When frequency is lower than  $(10-10*10\%) = 9\text{Hz}$ , DO1 outputs OFF signal.

F310	Characteristic current(A)	Setting range: 0~5000.0	Mfr's value: Rated current
F311	Characteristic current width(%)	Setting range: 0~100	Mfr's value: 10

When F300=17 and F301=17 and F302=17 and token characteristic current is selected, this group function codes set characteristic current and its width.

For example: setting F301=17, F310=100, F311=10, when inverter current is higher than F310, DO1 outputs ON signal. When inverter current is lower than  $(100-100*10\%) = 90\text{A}$ , DO1 outputs OFF signal.

F312	Frequency arrival threshold(Hz)	Setting range: 0.00~5.00	Mfr's value: 0.00
------	---------------------------------	--------------------------	-------------------

When F300=15 and F301=15, threshold range is set by F312.

For example: when F301=15, target frequency is 20HZ and F312=2, the running frequency reaches 18HZ (20-2), ON signal is output by DO1 until the running frequency reaches target frequency.

F313 Count frequency divisions	Setting range:1~65000	Mfr's value: 1
F314 Set count value	Setting range: F315~65000	Mfr's value: 1000
F315 Designated count value	Setting range: 1~F314	Mfr's value : 500

Count frequency divisions refer to the ratio of actual pulse input and inverter's count times, i.e.,

$$\text{Inverter's Count Times} = \frac{\text{Actual Pulse Input}}{\text{Count Frequency Division}}$$

E.g. when F313=3, inverter will count once for every 3 inputs of external pulse.

Set count values refer to a count width pulse output by the output terminal (DO1 terminal or relay) programmed with "reaching the set count values" function when a certain number of pulses are input from DI1. Count will restart after the count value reaches "set times".

As shown in Fig 5-6: if F313=1, F314=8, F301=8, DO1 will output an instruction signal when DI1 inputs the 8<sup>th</sup> pulse.

Designated count values refer to an pulse output by the output terminal (DO1 or RELAY terminal) programmed with "reaching the set count values" function when a certain number of pulses are input from DI1, until count value reaches the "set times".

As shown in Fig 5-10: if F313=1, F314=8, F315=5, F300=9, relay will output an instruction signal when DI1 inputs the 5<sup>th</sup> pulse, relay will output an instruction signal until reaching "set count times 8".

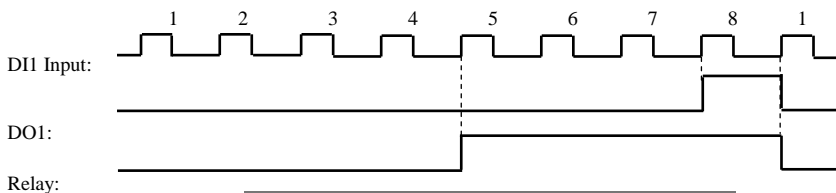

**Fig 5-7 Set Count times & Designated Count Times**

### 5.3.2 Digital multifunctional input terminals

F316 DI1 terminal function setting	Setting range: 0: no function; 1: running terminal; 2: stop terminal;	Mfr's value: 11
F317 DI2 terminal function setting	3: multi-stage speed terminal 1; 4: multi-stage speed terminal 2; 5: multi-stage speed terminal 3; 6: multi-stage speed terminal 4; 7: reset terminal;	Mfr's value: 9
F318 DI3 terminal function setting	8: free stop terminal; 9: external emergency stop terminal; 10: acceleration/deceleration forbidden terminal; 11: forward run jogging; 12: reverse run jogging;	Mfr's value: 15
F319 DI4 terminal function setting	13: UP frequency increasing terminal; 14: DOWN frequency decreasing terminal; 15: "FWD" terminal; 16: "REV" terminal;	Mfr's value: 16
F320 DI5 terminal function setting	17: three-line type input "X" terminal; 18: acceleration/deceleration time switchover 1; 19: Reserved; 20: Switchover between speed and torque	Mfr's value: 7
F321 DI6 terminal function setting	21: frequency source switchover terminal; 22: Count input terminal; 30: Water lack signal; 31: Signal of water 32: Fire pressure switchover; 33: Emergency fire control 34: Acceleration / deceleration switchover 2 35, 36:Reserved	Mfr's value: 8
F322 DI7 terminal function setting	37: Common-open PTC heat protection 38: Common-close PTC heat protection 42: oPEn protection terminal 49: PID pause 53: Watchdog 54: Frequency reset 55-59: Reserved	Mfr's value: 0
F323 DI8 terminal function setting	60:Communication timeout 2 signal elimination 61: Start/stop terminals	Mfr's value:0

This parameter is used for setting the corresponding function for multifunctional digital input terminal.

Both free stop and external emergency stop of the terminal have the highest priority.

When pulse given is selected, DI1 terminal is set as pulse signal input terminal automatically.

Note: Inverters of 15kW and below 15kW have 6 digital multifunctional input terminals DI1~DI6.

**Table 5-3 Instructions for digital multifunctional input terminal**

Value	Function	Instructions
0	No function	Even if signal is input, inverter will not work. This function can be set by undefined terminal to prevent mistake action.
1	Running terminal	When running command is given by terminal or terminals combination and this terminal is valid, inverter will run. This terminal has the same function with “run” key in keypad.
2	Stop terminal	When stop command is given by terminal or terminals combination and this terminal is valid, inverter will stop. This terminal has the same function with “stop” key in keypad.
3	Multistage speed terminal 1	15-stage speed is realized by combination of this group of terminals. See table 5-6.
4	Multistage speed terminal 2	
5	Multistage speed terminal 3	
6	Multistage speed terminal 4	
7	Reset terminal	This terminal has the same function with “reset” key in keypad. Long-distance malfunction reset can be realized by this function.
8	Free stop terminal	Inverter closes off output and motor stop process is not controlled by inverter. This mode is often used when load has big inertia or there are no requirements for stop time. This mode has the same function with free stop of F209.
9	External emergency stop terminal	When external malfunction signal is given to inverter, malfunction will occur and inverter will stop.
10	Acceleration/deceleration forbidden terminal	Inverter will not be controlled by external signal (except for stop command), and it will run at the current output frequency.
11	forward run jogging	Forward jogging running and reverse jogging running. Refer to F124, F125 and F126 for jogging running frequency, jogging acceleration/deceleration time.
12	reverse run jogging	
13	UP frequency increasing terminal	When frequency source is set by digital given, the setting frequency can be adjusted which rate is set by F211.
14	DOWN frequency decreasing terminal	
15	“FWD” terminal	When start/stop command is given by terminal or terminals combination, running direction of inverter is controlled by external terminals.
16	“REV” terminal	
17	Three-line input “X” terminal	“FWD”、“REV”、“CM” terminals realize three-line control. See F208 for details.
18	acceleration/deceleration time switchover 1	Please refer to Table 5-4.
19	Reserved	Reserved
20	Switchover between speed and torque	Switchover between rotary speed and torque

21	frequency source switchover terminal	When F207=2, main frequency source and accessorial frequency source can be switched over by frequency source switching terminal. When F207=3, X and (X + Y) can be switched over by frequency source switching terminal.
22	Count input terminal	Built-in count pulse input terminal.
30	Water lack signal	When PID control is valid and FA26=1, this function is valid. While lack of water, inverter will be in the protection state.
31	Signal of water	When PID control is valid and FA26=1, this function is valid. If water is enough, inverter will reset automatically.
32	Fire pressure switchover	When PID control is valid and this terminal is valid, the setting value of PID switches into fire pressure given (FA58).
33	Emergency fire control	When emergency fire mode (FA59) is valid, inverter will be in emergency fire mode.
34	Acceleration / deceleration switchover 2	Please refer to Table 5-4.
37	Common-open PTC heat protection	When this function is valid, common-open heat relay is externally connected. When common-open contact is closed and inverter is in the running status, inverter will trip into OH1.
38	Common-close PTC heat protection	When this function is valid, common-close heat relay is externally connected. When common-close contact is open and inverter is in the running status, inverter will trip into OH1.
42	oPEn protection terminal	oPEn protection function is enabled when setting digital input terminal as 42. When oPEn terminal is disabled, oPEn fault is valid, "oPEn" displays; oPEn protection auto reset when oPEn terminal is valid.
49	PID paused	PID adjustment is invalid temporarily.
53	Watchdog	During the time set by F326 elapses without an impulse being registered, inverter will trip into Err6, and inverter will stop according to stop mode set by F327.
54	Frequency reset	Current target frequency changes to setting value of F113 if frequency terminal is valid in application 4.
60	Communication timeout 2	When F907>0, and receiving the previous data, if after the time set by F907, the next data is not received, inverter will output communication timeout signal. The timeout signal will be cleared by this terminal, and after receiving correct data, inverter will accumulate time again.
61	Start-stop terminal	When the function is invalid, it is stop terminal. When the function is valid, it is start terminal.



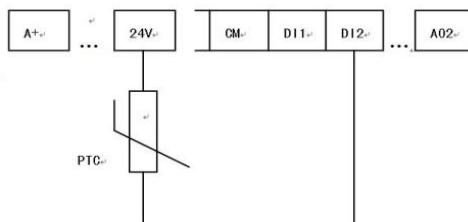

When the coding switch is in the end of “NPN”, PTC resistor should be connected between CM and D11 terminal. When the coding switch is in the end of “PNP”, PTC resistor should be connected between D11 and 24V. The recommended resistor value is 16.5K.

Because the precision of external PTC has some differences with optocoupler consistency, protection value precision will be bad, heat protection relay is suggested to be used.

**Table 5-4 Accel/decel selection**

Accel/decel switchover 2 (34)	Accel/decel switchover 1 (18)	Present accel/decel time	Related parameters
0	0	The first accel/decel time	F114, F115
0	1	The second accel/decel time	F116, F117
1	0	The third accel/decel time	F277, F278
1	1	The fourth accel/decel time	F279, F280

**Table 5-5**

**Instructions for multistage speed**

K4	K3	K2	K1	Frequency setting	Parameters
0	0	0	0	None	None
0	0	0	1	Multi-stage speed 1	F504/F519/F534/F549/F557/F565
0	0	1	0	Multi-stage speed 2	F505/F520/F535/F550/F558/F566
0	0	1	1	Multi-stage speed 3	F506/F521/F536/F551/F559/F567
0	1	0	0	Multi-stage speed 4	F507/F522/F537/F552/F560/F568
0	1	0	1	Multi-stage speed 5	F508/F523/F538/F553/F561/F569
0	1	1	0	Multi-stage speed 6	F509/F524/F539/F554/F562/F570
0	1	1	1	Multi-stage speed 7	F510/F525/F540/F555/F563/F571
1	0	0	0	Multi-stage speed 8	F511/F526/F541/F556/F564/F572
1	0	0	1	Multi-stage speed 9	F512/F527/F542/F573
1	0	1	0	Multi-stage speed 10	F513/F528/F543/F574
1	0	1	1	Multi-stage speed 11	F514/F529/F544/F575
1	1	0	0	Multi-stage speed 12	F515/F530/F545/F576
1	1	0	1	Multi-stage speed 13	F516/F531/F546/F577
1	1	1	0	Multi-stage speed 14	F517/F532/F547/F578
1	1	1	1	Multi-stage speed 15	F518/F533/F548/F579

Note: 1. K4 is multi-stage speed terminal 4, K3 is multi-stage speed terminal 3, K2 is multi-stage speed terminal 2, K1 is multi-stage speed terminal 1. And 0 stands for OFF, 1 stands for ON.

2. In table, 0=OFF, 1=ON

F324 Free stop terminal logic	Setting range: 0: positive logic; 1: negative logic	Mfr's value: 0
F325 External emergency stop terminal logic		Mfr's value: 0
F326 Watchdog time(S)	Setting range: 0.0: Invalid 0.1~3000.0	Mfr's value: 10.0
F327 Watchdog stop selection	Setting range: 0: Free to stop 1: Deceleration to stop	Mfr's value : 0
F328 Terminal filtering times	Setting range: 1~100	Mfr's value: 20

When multi-stage speed terminal is set to free stop terminal (8) and external emergency stop terminal (9), terminal logic level is set by this group of function codes. When F324=0 and F325=0, positive logic and low level is valid, when F324=1 and F325=1, negative logic and high level is valid.

When F326=0.0, watchdog function is invalid.

When F327=0, and during the time set by F326 elapses without an impulse being registered, inverter will free to stop and it will trip into Err6, and digital output token is valid.

When F327=1, and during the time set by F326 elapses without an impulse being registered, inverter will deceleration to stop, then inverter will trip into Err6, and digital output token is valid.

F329 Power-on terminal running command	Setting range: 0: command enabled 1: command disabled	Mfr's value: 0
---	--	----------------

When F329=0, after power-on, if the terminals which control inverter to start (running, fwd jog, rev jog, forward, reverse and three-line X input enabled) are enabled, the inverter starts to run directly.

When F329=1, after power-on, if the terminals which control inverter to start (running, fwd jog, rev jog, forward, reverse and three-line X input enabled) are enabled, user needs to disconnect terminals again and make the terminal enabled again, then the inverter runs.

F330 Status display of digital input terminals	Read only
--	-----------

F330 is used to display the diagnostics of DIX terminals.

Please refer to Fig 5-8 about the indicators of DIX digital input terminals, the solid-line box and dotted-line box indicate the invalid and valid respectively.

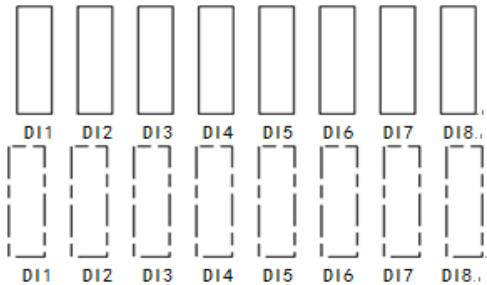

**Figure 5-8 Status of digital input terminals**

Set F645=22, press “SET”, switch interface by “FUN” key to display 8 boxes. Shorting to DI1~DI8, terminals are valid if number turns from 0 to 1, and eight dotted-line boxes are displayed; Terminals are invalid if number does not turn to 1, and eight solid-line boxes are displayed.

If user wants to see the detailed status for each terminal, set the function code as F330, press “SET” to enter diagnosis interface, which is showed below.

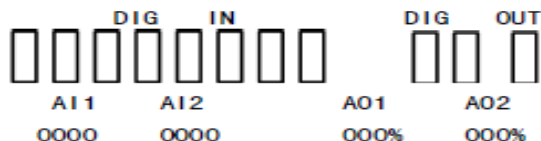

The first line indicates digital input, digital output; First eight boxes in the second line indicate the state of DI terminals, terminals from left to right are DI1~DI8, solid-line box is the state showed as above when terminal is invalid; Black box is displayed when terminal is valid. E.g. If all 8 terminals are valid, will be displayed.

The last three boxes represent the terminal output status of DO1, relay 1 and relay 2, which display mode is the same as DI terminals. E.g. If 3 terminals are valid at same time, will be displayed.

The third line indicates the name of AI1, AI2 and AO1, AO2. The value displayed in fourth line correspond to the content of third line.

E.g. AI1 AI2 AO1 AO2  
2010 0000 000% 000%

It means the value of AI1 is 2010, so are the rest three values.

After checking diagnosis interface, if user needs to exit interface, press “FUN” key to enter first-level menu.

#### Relay/Digital output simulation

F335	Relay output simulation	Setting range: 0: Output inactive. 1: Output active.	Mfr's value: 0
F336	DO1 output simulation		Mfr's value: 0
F337	DO2 output simulation		Mfr's value: 0

Take an example of DO1 output simulation, when inverter is in the stop status and enter F336, press the UP key, the DO1 terminal is valid. Relax the UP key, DO1 remains valid status. After quitting F336, DO1 will revert to initial output status.

#### Analog output simulation

F338	AO1 output simulation	Setting range: 0~4095	Mfr's value: 0
F339	AO2 output simulation	Setting range: 0~4095	Mfr's value: 0

When inverter is in the stop status, and enter F338 or F339, press the UP key, the output analog will increase, and when press the DOWN key, the output analog will decrease. If relax the key, analog output remains stable. After quitting the parameters, AO1 and AO2 will revert to initial output status.

F340 DI terminal negative logic Selection	Setting range: 0: Invalid 1: DI1 negative logic 2: DI2 negative logic 4: DI3 negative logic 8: DI4 negative logic 16: DI5 negative logic 32: DI6 negative logic 64: DI7 negative logic 128: DI8 negative logic	Mfr's value: 0
---	--	----------------

For example: if user wants to set DI1 and DI4 to negative logic, please set F340=1+8=9.

F343	Delay time of DI1 ON	Setting range: 0.00~99.99	Mfr's value: 0.00
F344	Delay time of DI2 ON	Setting range: 0.00~99.99	Mfr's value: 0.00
F345	Delay time of DI3 ON	Setting range: 0.00~99.99	Mfr's value: 0.00
F346	Delay time of DI4 ON	Setting range: 0.00~99.99	Mfr's value: 0.00
F347	Delay time of DI5 ON	Setting range: 0.00~99.99	Mfr's value: 0.00
F348	Delay time of DI6 ON	Setting range: 0.00~99.99	Mfr's value: 0.00
F349	Delay time of DI7 ON	Setting range: 0.00~99.99	Mfr's value: 0.00
F350	Delay time of DI8 ON	Setting range: 0.00~99.99	Mfr's value: 0.00
F351	Delay time of DI1 OFF	Setting range: 0.00~99.99	Mfr's value: 0.00
F352	Delay time of DI2 OFF	Setting range: 0.00~99.99	Mfr's value: 0.00
F353	Delay time of DI3 OFF	Setting range: 0.00~99.99	Mfr's value: 0.00
F354	Delay time of DI4 OFF	Setting range: 0.00~99.99	Mfr's value: 0.00
F355	Delay time of DI5 OFF	Setting range: 0.00~99.99	Mfr's value: 0.00
F356	Delay time of DI6 OFF	Setting range: 0.00~99.99	Mfr's value: 0.00
F357	Delay time of DI7 OFF	Setting range: 0.00~99.99	Mfr's value: 0.00
F358	Delay time of DI8 OFF	Setting range: 0.00~99.99	Mfr's value: 0.00

F359	Stop command priority	Setting range: 0: Invalid 1: Valid	Mfr's value: 0
------	-----------------------	------------------------------------	----------------

When F359=1, if inverter get stop command when run command is valid, inverter will stop first. Inverter will start again only after disconnecting the start terminal first and connect it again.

F360	Output terminal negative logic	Setting range: 0: Invalid 1: DO1 negative logic 2: DO2 negative logic 4: Relay 1	Mfr's value: 0
------	--------------------------------	--	----------------

F360 is used as output terminal negative logic

For example: set DO1 as negative logic, then F360=1; set DO2 as negative logic, then F360=2; Set relay 1 as negative logic, then F360=4; If both DO1 and DO2 are negative logic, then F360=1+2=3, and so on.

## 5.4 Analog Input and Output

EP66 series inverters have 2 analog input channels and 2 analog output channels.

F400	Lower limit of AI1 channel input (V)	Setting range: 0.00~F402	Mfr's value: 0.04
F401	Corresponding setting for lower limit of AI1 input	Setting range: 0.00~2.00	Mfr's value: 1.00
F402	Upper limit of AI1 channel input (V)	Setting range: F400~10.00	Mfr's value: 10.00
F403	Corresponding setting for upper limit of AI1 input	Setting range: 0.00~2.00	Mfr's value: 2.00
F404	AI1 channel proportional gain K1	Setting range: 0.0~10.0	Mfr's value: 1.0
F405	AI1 filtering time constant (S)	Setting range: 0.10~10.0	Mfr's value: 0.10

In the mode of analog speed control, sometimes it requires adjusting coincidence relation among upper limit and lower limit of input analog, analog changes and output frequency, to achieve a satisfactory speed control effect.

·Upper and lower limit of analog input are set by F400 and F402.

For example: when F400=1, F402=8, if analog input voltage is lower than 1V, system judges it as 0. If input voltage is higher than 8V, system judges it as 10V (Suppose analog channel selects 0-10V). If Max frequency F111 is set to 50Hz, the output frequency corresponding to 1-8V is 0-50Hz.

·The filtering time constant is set by F405.

The greater the filtering time constant is, the more stable for the analog testing. However, the precision may decrease to a certain extent. It may require appropriate adjustment according to actual application.

·Channel proportional gain is set by F404.

If 1V corresponds to 10Hz and F404=2, then 1V will correspond to 20Hz.

·Corresponding setting for upper / lower limit of analog input are set by F401 and F403.

If Max frequency F111 is 50Hz, analog input voltage 0-10V can correspond to output frequency from -50Hz to 50Hz by setting this group function codes. Please set F401=0 and F403=2, then 0V corresponds to -50Hz, 5V corresponds to 0Hz and 10V corresponds to 50Hz. The unit of corresponding setting for upper / lower limit of input is in percentage (%). If the value is greater than 1.00, it is positive; if the value is less than 1.00, it is negative. (e.g. F401=0.5 represents -50%).

If the running direction is set to forward running by F202, then 0-5V corresponding to the minus frequency will cause reverse running, or vice versa.

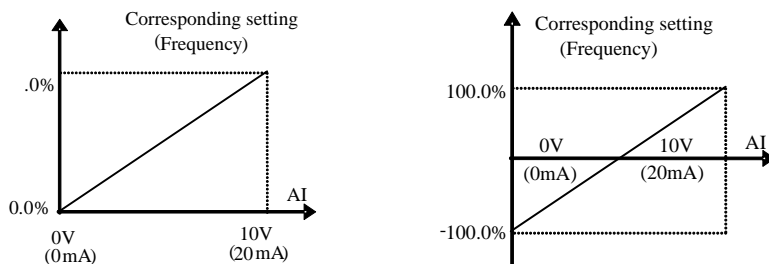

Figure 5-9 Correspondence of analog input to setting

The unit of corresponding setting for upper / lower limit of input is in percentage (%). If the value is greater than 1.00, it is positive; if the value is less than 1.00, it is negative. (e.g. F401=0.5 represents -50%).The corresponding setting benchmark: in the mode of combined speed control, analog is the accessorial frequency and the setting benchmark for range of accessorial frequency which relates to main frequency is “main frequency X”; corresponding setting benchmark for other cases is the “max frequency”, as illustrated in figure 5-10:

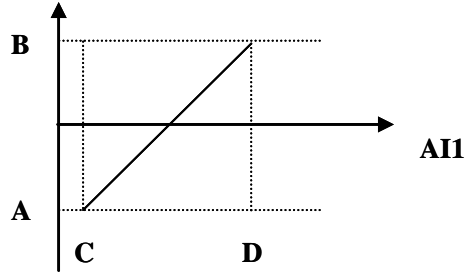

Figure 5-10 Relations of analog given and setting value

A= (F401-1)\* setting value    B= (F403-1)\* setting value    C= F400    D= F402

F406	Lower limit of AI2 channel input (V)	Setting range: 0.00~F408	Mfr's value: 0.04
F407	Corresponding setting for lower limit of AI2 input	Setting range: 0~2.00	Mfr's value: 1.00
F408	Upper limit of AI2 channel input (V)	Setting range: F406~10.00V	Mfr's value: 10.00
F409	Corresponding setting for upper limit of AI2 input	Setting range: 0.00~2.00	Mfr's value: 2.00
F410	AI2 channel proportional gain K2	Setting range: 0.0~10.0	Mfr's value: 1.0
F411	AI2 filtering time constant (S)	Setting range: 0.10~10.00	Mfr's value: 0.10

The function of AI2 is the same as AI1.

F418	AI1 channel 0Hz voltage dead zone	Setting range: 0~1.00	Mfr's value: 0.00
F419	AI2 channel 0Hz voltage dead zone	Setting range: 0~1.00	Mfr's value: 0.00

Analog input voltage 0-5V can correspond to output frequency -50Hz-50Hz (2.5V corresponds to 0Hz) by setting the function of corresponding setting for upper / lower limit of analog input. The group function codes of F418 and F419 set the voltage range corresponding to 0Hz. For example, when F418=0.5 and F419=0.5, the voltage range from (2.5-0.5=2) to (2.5+0.5=3) corresponds to 0Hz. So if F418=N, F419=N, then 2.5±N should correspond to 0Hz. If the voltage is in this range, inverter will output 0Hz.

0Hz voltage dead zone will be valid when corresponding setting for lower limit of input is less than 1.00.

F423	AO1 output range	Setting range: 0: 0~5V; 1: 0~10V or 0~20mA 2: 4~20mA	Mfr's value: 1
F424	AO1 lowest corresponding frequency (Hz)	Setting range: 0.0~F425	Mfr's value: 0.05
F425	AO1 highest corresponding frequency (Hz)	Setting range: F424~F111	Mfr's value: 50.00
F426	AO1 output compensation (%)	Setting range: 0~120	Mfr's value: 100

-AO1 output range is selected by F423. When F423=0, AO1 output range selects 0-5V, and when F423=1, AO1 output range selects 0-10V or 0-20mA. When F423=2, AO1 output range selects 4-20mA (When AO1 output range selects current signal, please turn the switch J5 to “I” position)

-Correspondence of output voltage range (0-5V or 0-10V) to output frequency is set by F424 and F425. For example, when F423=0, F424=10 and F425=120, analog channel AO1 outputs 0-5V and the output frequency is 10-120Hz.

-AO1 output compensation is set by F426. Analog excursion can be compensated by setting F426.

F427	AO2 output range	Setting range: 0: 0~20mA; 1: 4~20 mA	Mfr's value: 0
------	------------------	---	----------------

F428	AO2 lowest corresponding frequency (Hz)	Setting range: 0.0~F429	Mfr's value: 0.05
F429	AO2 highest corresponding frequency (Hz)	Setting range: F428~F111	Mfr's value: 50.00
F430	AO2 output compensation (%)	Setting range: 0~120	Mfr's value: 100

The function of AO2 is the same as AO1, but AO2 will output current signal, current signal of 0-20mA and 4-20mA could be selected by F427.

F431	AO1 analog output signal selection (below 15kw)	Setting range: 0: Running frequency; 1: Output current; 2: Output voltage; 3: AI1 4: AI2 5: Input pulse 6: Output torque 7: Given by PC/PLC 8: Target frequency 9: Actual speed 10: Output torque 2 11. Reserved 12: Output power 13:DO2 output	Mfr's value: 0
F432	AO2 analog output signal selecting		Mfr's value: 1

Token contents output by analog channel are selected by F431 and F432. Token contents include running frequency, output current and output voltage.

**13: DO2 output: F302=1, F431=13, F423=1, and analog coding switch turns to voltage, after fault occurs, AO1 output 10V. After the fault is reset, AO1 output 0V. if coding switch turns to current, AO1 will output 0mA or 20mA.**

When output current is selected, analog output signal is from 0 to twofold rated current.

When output voltage is selected, analog output signal is from 0V to rated output voltage.

When actual speed is selected, actual speed in vector mode, synchro-speed in other mode.

F433	Corresponding current for full range of external voltmeter	Setting range: 0.01~5.00 times of rated current	Mfr's value: 2.00
F434	Corresponding current for full range of external ammeter		Mfr's value: 2.00

In case of F431=1 and AO1 channel for token current, F433 is the ratio of measurement range of external voltage type ammeter to rated current of the inverter.

In case of F432=1 and AO2 channel for token current, F434 is the ratio of measurement range of external current type ammeter to rated current of the inverter.

For example: measurement range of external ammeter is 20A, and rated current of the inverter is 8A, then, F433=20/8=2.50. Note: Below 15kw inverters have no AO2 terminal.

F435	Corresponding multiple of rated power for output max analog value	Setting range: 0.01~3.00	Mfr's value:2.00
------	---	-----------------------------	------------------

Analog output range is token as 0.01~3.00 times of torque power

F436	corresponding current multiple of rated torque for output max analog value	Setting range: 0.01~3.00	Mfr's value: 3.00
------	--	-----------------------------	-------------------

In vector control mode, analog is 0.01~3.00 times of torque current.

F438	Input signal of AI1 channel	Setting range: 0: voltage 1: current	Mfr's value: 0
F439	Input signal of AI2 channel	Setting range: 0: voltage 1: current	Mfr's value: 1

When F438=0, AI1 channel is vlotage signal input, when F438=1, AI1 channel is current signal input.

When F439=0, AI1 channel is vlotage signal input, when F439=1, AI1 channel is current signal input.

The input signal should be matched with this parameter setting, and coding switch should be referred to Table 4-2 and 4-3.

## 5.5 Pulse input/output

F440 Min frequency of input pulse FI (KHz)	Setting range: 0.00~F442	Mfr's value: 0.00
F441 Corresponding setting of FI min frequency	Setting range:0.00~F443	Mfr's value: 1.00
F442 Max frequency of input pulse FI (KHz)	Setting range: F440~100.00	Mfr's value: 10.00
F443 Corresponding setting of FI max frequency	Setting range: Max (1.00, F441) ~2.00	Mfr's value: 2.00
F445 Filtering constant of FI input pulse	Setting range: 0~1000	Mfr's value: 0
F446 FI channel 0Hz frequency dead zone (KHz)	Setting range: 0~F442 (Positive-Negative)	Mfr's value: 0.00

·When inverter is controlled by pulse frequency, DI1 is defined as pulse signal input port automatically.

Min frequency of input pulse is set by F440 and max frequency of input pulse is set by F442.

For example: when F440=0K and F442=10K, and the max frequency is set to 50Hz, then input pulse frequency 0-10K corresponds to output frequency 0-50Hz.

Filtering time constant of input pulse is set by F445.

The greater the filtering time constant is, the more steady pulse measurement, but precision will be lower, so please adjust it according to the application situation.

Corresponding setting of min frequency is set by F441 and corresponding setting of max frequency is set by F443. When the max frequency is set to 50Hz, pulse input 0-10K can correspond to output frequency -50Hz-50Hz by setting this group function codes. Please set F441 to 0 and F443 to 2, then 0K corresponds to -50Hz, 5K corresponds to 0Hz, and 10K corresponds to 50Hz. The unit of corresponding setting for max/min pulse frequency is in percentage (%). If the value is greater than 1.00, it is positive; if the value is less than 1.00, it is negative.

If the running direction is set to forward running by F202, 0-5K corresponding to the minus frequency will cause reverse running, or vice versa.

·0 Hz frequency dead zone is set by F446.

Input pulse 0-10K can correspond to output frequency -50Hz~50Hz (5K corresponds to 0Hz) by setting the function of corresponding setting for max/min input pulse frequency. The function code F446 sets the input pulse range corresponding to 0Hz. For example, when F446=0.5, the pulse range from (5K-0.5K=4.5K) to (5K+0.5K=5.5K) corresponds to 0Hz. So if F446=N, then  $5 \pm N$  should correspond to 0Hz. If the pulse is in this range, inverter will output 0Hz.

0HZ voltage dead zone will be valid when corresponding setting for min pulse frequency is less than 1.00.

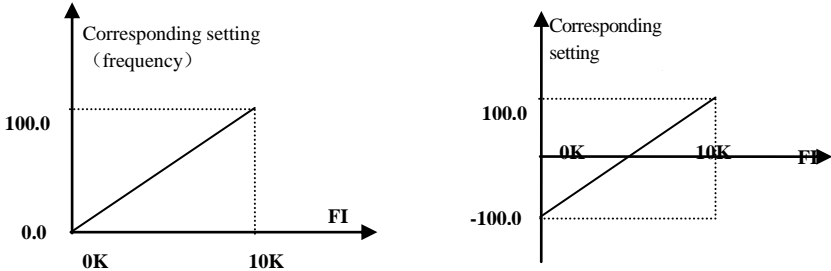

Figure 5-11 Correspondence of pulse input and setting



The unit of corresponding setting for max/min input pulse frequency is in percentage (%). If the value is greater than 1.00, it is positive; if the value is less than 1.00, it is negative. (e.g. F441=0.5 represents -50%). The corresponding setting benchmark: in the mode of combined speed control, pulse input is the accessorial frequency and the setting benchmark for range of accessorial frequency which relates to main frequency (F205=1) is “main frequency X”; corresponding setting benchmark for other cases is the “max frequency”, as illustrated in the right figure:

A= (F441-1)\*setting benchmark

B= (F443-1)\*setting benchmark

C= F440

F= F442

(E-D)/2=F446

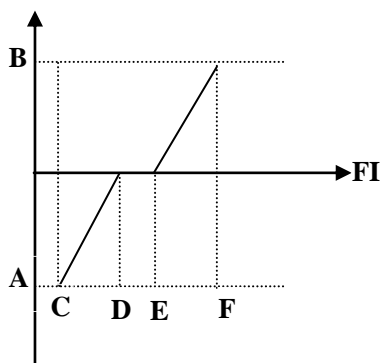

Figure 5-12 relationship between pulse input and setting value

F449 Max frequency of FO output pulse (KHz)	Setting range: 0.00~100.00	Mfr's value: 10.00
F450 Zero bias coefficient of output pulse frequency (%)	Setting range: 0.0~100.0	Mfr's value: 0.0
F451 Frequency gain of FO output pulse	Setting range: 0.00~10.00	Mfr's value: 1.00
F453 FO output pulse signal	Setting range: 0: Running frequency 1: Output current 2: Output voltage 3: AI1 4: AI2 5: Input pulse 6: Output torque 7: Given by PC/PLC 8: Target frequency	Mfr's value: 0

When DO1 is defined as high-speed pulse output terminal, the max frequency of output pulse is set by F449.

If “b” stands for zero bias coefficient, “k” stands for gain, “Y” stands for actual output of pulse frequency and “X” stands for standard output, then  $Y=Kx+b$ .

Standard output X is the token value corresponding to output pulse min/max frequency, which range is from zero to max value.

-100 percent of zero bias coefficient of output pulse frequency corresponds to the max output pulse frequency (the set value of F449.)

Frequency gain of output pulse is set by F451. User can set it to compensate the deviation of output pulse. Output pulse token object is set by F453. For example: running frequency, output current and output voltage, etc.

When output current is displayed, the range of token output is 0-2 times of rated current.

When output voltage is displayed, the range of token output is from 0-1.2 times of rated output voltage.

F460	AI1 channel input mode	Setting range: 0: straight line mode 1: folding line mode	Mfr's value: 0
F461	AI2 channel input mode	Setting range: 0: straight line mode 1: folding line mode	Mfr's value: 0
F462	AI1 insertion point A1 voltage value (V)	Setting range: F400~F464	Mfr's value: 2.00
F463	AI1 insertion point A1 setting value	Setting range: 0.00~2.00	Mfr's value: 1.20
F464	AI1 insertion point A2 voltage value (V)	Setting range: F462~F466	Mfr's value: 5.00
F465	AI1 insertion point A2 setting value	Setting range: 0.00~2.00	Mfr's value: 1.50
F466	AI1 insertion point A3 voltage value (V)	Setting range: F464~F402	Mfr's value: 8.00
F467	AI1 insertion point A3 setting value	Setting range: 0.00~2.00	Mfr's value: 1.80
F468	AI2 insertion point B1 voltage value (V)	Setting range: F406~F470	Mfr's value: 2.00
F469	AI2 insertion point B1 setting value	Setting range: 0.00~2.00	Mfr's value: 1.20
F470	AI2 insertion point B2 voltage value (V)	Setting range: F468~F472	Mfr's value: 5.00
F471	AI2 insertion point B2 setting value	Setting range: 0.00~2.00	Mfr's value: 1.50
F472	AI2 insertion point B3 voltage value (V)	Setting range: F470~F408	Mfr's value: 8.00
F473	AI2 insertion point B3 setting value	Setting range: 0.00~2.00	Mfr's value: 1.80

When analog channel input mode selects straight-line, please set it according to the parameters from F400 to F429. When folding line mode is selected, three points A1(B1) , A2(B2), A3(B3) are inserted into the straight line, each of which can set the according frequency to input voltage. Please refer to the following figure:

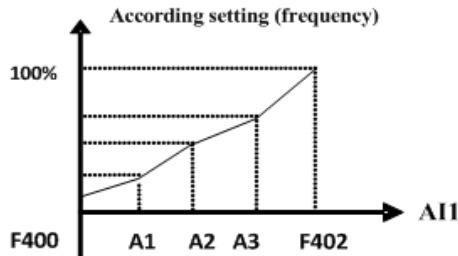

Figure 5-13 Folding analog with setting value

F400 and F402 are lower/upper limit of analog AI1 input. When F460=1, F462=2.00V, F463=1.4, F111=50, F203=1, F207=0, then A1 point corresponding frequency is  $(F463-1) * F111=20\text{Hz}$ , which means 2.00V corresponding to 20Hz. The other points can be set by the same way. AI2 channel has the same setting way as AI1.

## 5.6 Multi-stage Speed Control

The function of multi-stage speed control is equivalent to a built-in PLC in the inverter. This function can set running time, running direction and running frequency.

EP66 series inverter can realize 15-stage speed control and 8-stage speed auto circulating.

During the process of speed track, multi-stage speed control is invalid. After speed track is finished, inverter will run to target frequency according to the setting value of parameters.

F500	Stage speed type	Setting range: 0: 3-stage speed; 1: 15-stage speed; 2: Max 8-stage speed auto circulating	Mfr's value: 1
------	------------------	---	----------------

In case of multi-stage speed control (F203=4), the user must select a mode by F500. When F500=0, 3-stage speed is selected. When F500=1, 15-stage speed is selected.

When F500=2, max 8-stage speed auto circulating is selected. When F500=2, "auto circulating" is classified into "2-stage speed auto circulating", "3-stage speed auto circulating", ... "8-stage speed auto circulating", which is to be set by F501.

**Table 5-6 Selection of Stage Speed Running Mode**

F203	F500	Mode of Running	Description
4	0	3-stage speed control	The priority in turn is stage-1 speed, stage-2 speed and stage-3 speed. It can be combined with analog speed control. If F207=4, "3-stage speed control" is prior to analog speed control.
4	1	15-stage speed control	It can be combined with analog speed control. If F207=4, "15-stage speed control" is prior to analog speed control.
4	2	Max 8-stage speed auto circulating	Adjusting the running frequency manually is not allowable. "2-stage speed auto circulating", "3-stage speed auto circulating", ... "8-stage speed auto circulating" may be selected through setting the parameters.

F501	Selection of Stage Speed Under Auto-circulation Speed Control	Setting range: 2~8	Mfr's value: 7
F502	Selection of Times of Auto-circulation Speed Control	Setting range: 0~9999 (0 is infinite circulating)	Mfr's value: 0
F503	Status After Auto-circulation Running Finished.	Setting range: 0: Stop 1: Keep running at last-stage speed	Mfr's value: 0

If running mode is auto-circulation speed control (F203=4, F500=2), set related parameters by F501~F503.

The inverter runs at the preset stage speed under the auto-circulation speed control is called as "one time".

If F502=0, inverter will run at infinite auto circulation, which will be stopped by "stop" signal.

If F502>0, inverter will run at auto circulation conditionally. When auto circulation of the preset times is finished continuously (set by F502), inverter will finish auto-circulation running conditionally. When inverter keeps running and the preset times is not finished, if inverter receives "stop command", inverter will stop. If inverter receives "run command" again, inverter will automatically circulate by the setting time of F502.

If F503=0, then inverter will stop after auto circulation is finished. If F503=1, then inverter will run at the speed of the last-stage after auto-circulation is finished as follows:

E.g., F501=3, then inverter will run at auto circulation of 3-stage speed;

F502=100, then inverter will run 100 times of auto circulation;

F503=1, inverter will run at the speed of the last stage after the auto-circulation running is finished.

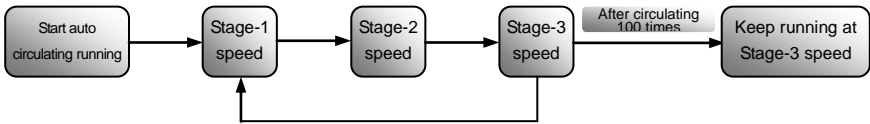

Figure 5-14 Auto-circulating Running

Inverter stops by pressing “stop” or sending “stop” signal through terminal during auto-circulation running.

F504	Frequency setting for stage 1 speed (Hz)	Setting range: F112~F111	Mfr's value: 5.00	
F505	Frequency setting for stage 2 speed (Hz)		Mfr's value: 10.00	
F506	Frequency setting for stage 3 speed (Hz)		Mfr's value: 15.00	
F507	Frequency setting for stage 4 speed (Hz)		Mfr's value: 20.00	
F508	Frequency setting for stage 5 speed (Hz)		Mfr's value: 25.00	
F509	Frequency setting for stage 6 speed (Hz)		Mfr's value: 30.00	
F510	Frequency setting for stage 7 speed (Hz)		Mfr's value: 35.00	
F511	Frequency setting for stage 8 speed (Hz)		Mfr's value: 40.00	
F512	Frequency setting for stage 9 speed (Hz)		Mfr's value: 5.00	
F513	Frequency setting for stage 10 speed (Hz)		Mfr's value: 10.00	
F514	Frequency setting for stage 11 speed (Hz)		Mfr's value: 15.00	
F515	Frequency setting for stage 12 speed (Hz)		Mfr's value: 20.00	
F516	Frequency setting for stage 13 speed (Hz)		Mfr's value: 25.00	
F517	Frequency setting for stage 14 speed (Hz)		Mfr's value: 30.00	
F518	Frequency setting for stage 15 speed (Hz)		Mfr's value: 35.00	
F519~F533	Acceleration time setting for the speeds from Stage 1 to Stage 15 (S)		Setting range: 0.1~3000	Subject to inverter model
F534~F548	Deceleration time setting for the speeds from Stage 1 to Stage 15 (S)		Setting range: 0.1~3000	
F549~F556	Running directions of stage speeds from Stage 1 to Stage 8 (S)		Setting range: 0: forward running; 1: reverse running	Mfr's value: 0
F573~F579	Running directions of stage speeds from stage 9 to stage 15 (S)	Setting range: 0: forward running; 1: reverse running	Mfr's value: 0	
F557~564	Running time of stage speeds from Stage 1 to Stage 8 (S)	Setting range: 0.1~3000	Mfr's value: 1.0	
F565~F572	Stop time after finishing stages from Stage 1 to Stage 8 (S)	Setting range: 0.0~3000	Mfr's value: 0.0	
F580	Stage speed mode selection	Setting range: 0: Stage speed mode 1 1: Stage speed mode 2	Mfr's value: 0	

When F580=0, in 15-stage speed, terminal code status 0000 is invalid status, 1111 is 15<sup>th</sup> stage speed.

When F580=1, in 15-stage speed, terminal code status 0000 is 1<sup>st</sup> stage speed, and 1111 is invalid status.

## 5.7 Auxiliary Functions

F600 DC Braking Function Selection	Setting range: 0: Invalid; 1: braking before starting; 2: braking during stopping; 3: braking during starting and stopping	Mfr's value: 0
F601 Initial Frequency for DC Braking (Hz)	Setting range: 0.20~50.00	Mfr's value: 1.00
F602 DC Braking efficiency before Starting	Setting range: $\leq 30\text{kW}$ : 0~250 $> 30\text{kW}$ : 0~200	Mfr's value: 50
F603 DC Braking efficiency During Stop		Mfr's value: 100
F604 Braking Lasting Time Before Starting (S)	Setting range: 0.00~30.00	Mfr's value: 0.50
F605 Braking Lasting Time During Stopping (S)		
F656 DC braking waiting time during stopping(s)	Setting range: 0.00~30.00	Mfr's value: 0

When F600=0, DC braking function is invalid.

When F600=1, braking before starting is valid. After the right starting signal is input, inverter starts DC braking. After braking is finished, inverter will run from the initial frequency.

In some application occasion, such as fan, motor is running at a low speed or in a reverse status, if inverter starts immediately, OC malfunction will occur. Adopting "braking before starting" will ensure that the fan stays in a static state before starting to avoid this malfunction.

During braking before starting, if "stop" signal is given, inverter will stop by deceleration time.

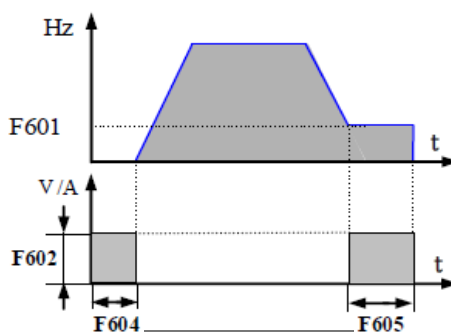

Figure 5-15 DC braking

When F600=2, DC braking during stopping is selected. After output frequency is lower than the initial frequency for DC braking (F601), DC braking will stop the motor immediately

During the process of braking during stopping, if "start" signal is given, DC braking will be finished and inverter will start.

If "stop" signal is given during the process of braking during stopping, inverter will have no response and DC braking during stopping still goes on.

When jogging function is valid, the function of braking before starting set by F600 is valid, and the function of speed track is invalid.

When jogging function is invalid and F613-1, the function of braking before starting is invalid.

Parameters related to "DC Braking": F601, F602, F603, F604, F605, interpreted as follows:

- F601: Initial frequency of DC-braking. DC braking will start to work as inverter's output frequency is lower than this value.
- F602/F603: DC braking efficiency. The bigger value will result in a quick braking. However, motor will overheat with too big value.
- F604: Braking duration before starting. The time lasted for DC braking before inverter starts.
- F605: Braking duration when stopping. The time lasted for DC braking while inverter stops.

DC braking, as shown in Figure 5-16.

Note: during DC braking, because motor does not have self-cool effect cause by rotating, it is in the state of easy over-heat. Please do not set DC braking voltage too high and do not set DC braking time to long.

F607	Selection of Stalling Adjusting Function	Setting range: 0~ 2:Reserved 3: Voltage/current control 4: Voltage control 5: Current control	Mfr's value: 3
F608	Stalling Current Adjusting (%)	Setting range: 25~FC49	Mfr's value: 160
F609	Stalling Voltage Adjusting (%)	Setting range: 110~200	Mfr's value: S2/T2: 130 T3: 140
F610	Stalling Protection Judging Time (S)	Setting range: 0.1~3000.0	Mfr's value: 0.0

F607 is used to set selection of stalling adjusting function.

Voltage control: when motor stops quickly or load changes suddenly, DC bus voltage will be high. Voltage control function can adjust deceleration time and output frequency to avoid OE.

When braking resistor or braking unit is used, please do not use voltage control function. Otherwise, the deceleration time will be changed.

Current control: when motor accelerates quickly or load changed suddenly, inverter may trip into OC. Current control function can adjust accel/decel time or decrease output frequency to control proper current value. It is only valid in VF control mode.

Note: (1) Voltage/current control is not suitable for lifting application.

(2) This function will change accel/decel time. Please use this function properly.

(3) Please do not use this function when one inverter drives two motors.

Initial value of stalling current adjusting is set by F608, when the present current is higher than rated current \*F608, stalling current adjusting function is valid.

During the process of deceleration, stalling current function is invalid.

During the process of acceleration, if output current is higher than initial value of stalling current adjusting and F607=1, then stalling adjusting function is valid. Inverter will not accelerate until the output current is lower than initial value of stalling current adjusting.

In case of stalling during stable speed running, the frequency will drop. If the current returns to normal during dropping, the frequency will return to rise. Otherwise, the frequency will keep dropping to the minimum frequency and the protection OLI will occur after it lasts for the time as set in F610.

Initial value of stalling voltage adjusting is set by F609, when the present voltage is higher than rated voltage \*F609, stalling voltage adjusting function is valid.

Stalling voltage adjusting is valid during the process of deceleration, including the deceleration process caused by stalling current.

Over-voltage means the DC bus voltage is too high and it is usually caused by decelerating. During the process of deceleration, DC bus voltage will increase because of energy feedback. When DC bus voltage is higher than the initial value of stalling voltage and F607=1, then stalling adjusting function is valid. Inverter will temporarily stop decelerating and keep output frequency constant, then inverter stops energy feedback. Inverter will not decelerate until DC bus voltage is lower than the initial value of stalling voltage.

Stalling protection judging time is set by F610. When inverter starts stalling adjusting function and continues the setting time of F610, inverter will stop running and OLI protection occurs.

F611	Dynamic Braking threshold (V)	Setting range: T3:600~2000 S2/T2:320~2000	Subject to inverter model
F612	Dynamic braking duty ratio (%)	Setting range: 0~100	Mfr's value: 100

Initial voltage of dynamic braking threshold is set by F611, which of unit is V. When DC bus voltage is higher than the setting value of this function, dynamic braking starts, braking unit starts working. After DC bus voltage is lower than the setting value, braking unit stops working.

The value of F611 should be set according to input voltage. When the input voltage is 400V, F611 should be set to 700V, when input voltage is 460V, F611 should be set to 770V. The lower the dynamic braking threshold is, the better dynamic braking effect is. But the heat of braking resistor is more serious. The higher the dynamic braking threshold is, the worse dynamic braking effect is. And at the process of braking, inverter will easily trip to OE.

Dynamic braking duty ratio is set by F612, the range is 0~100%. The value is higher, the braking effect is better, but the braking resistor will get hot.

F613 Speed track	Setting range: 0: invalid 1: valid 2: valid at the first time	Mfr's value: 0
------------------	---	----------------

When F613=0, the function of speed track is invalid.

When F613=1, the function of speed track is valid.

After inverter tracks motor speed and rotating direction, inverter will begin running according to the tracked frequency, to start the rotating motor smoothly. This function is suitable for the situation of auto-starting after repowered on, auto-starting after reset, auto-starting when running command valid but direction signal lost and auto-starting when running command invalid.

When F613=2, the function is valid at the first time after inverter is repower on.

Note: When F106=0, speed track function is invalid.

F614 Speed track mode	Setting range: 0: Speed track from frequency memory 1: Speed track from max frequency 2: Speed track from frequency memory and direction memory	Mfr's value: 0
-----------------------	--	----------------

When F614 is set to 0, inverter will track speed down from frequency memory.

When F614 is set to 1, inverter will track speed up from max frequency.

When F614 is set to 2, inverter will track speed down from 0Hz.

F615 Speed track rate	Setting range: 1~100	Mfr's value: 20
-----------------------	----------------------	-----------------

It is used to select the rotation velocity speed track when the rotation tracking restart mode is adopted. The larger the parameter is, the faster the speed track is. But if this parameter is too large, it likely results in unreliable tracking.

F618 Delay time of speed track (S)	Setting range: 0.5~60.0	Mfr's value: 1.5
------------------------------------	-------------------------	------------------

F620 Brake delay turn-off time	Setting range: 0.0 (brake not closed when stop) 0.1~3000	Mfr's value: 5.0
--------------------------------	--	------------------

F620=0, dynamic brake is not closed in stop status, it starts when PN voltage is higher than brake point; F620≠0, dynamic brake can proceed normally when inverter is running, the time set by F620 is the delay time after stop, then the dynamic brake closes automatically.

F621 LCD background adjustment	Setting range: 0: White background 1: Inverse background	Mfr's value: 0
-----------------------------------	--	----------------

F621=0, current LCD keypad has white background.

F621=1, the color of current LCD keypad is inverse with the manufacturer color, which means the original background color turns to font color, and the original font color changes to background color.

F638 Parameters copy enabled	Setting range: 0: Copy forbidden 1: Parameters download 1 (voltage level and power are totally same) 2: Parameters download 2 (without considering voltage level and power)	Mfr's value: 1
F639 Parameters copy code	Setting range: 3000~3499	Mfr's value: subject to the model
F640 Parameter copy type	Setting range: 0: Copy all parameters 1: Copy parameters (except motor parameters from F801 to F810/F844)	Mfr's value: 1

Please refer to the user manual of parameters copy.

The fault is as following:

Code	Causes
Er71 Copy timeout	During copying process, there is no valid data after 3s.
Er72 Copy when running	Parameters copy when inverter is in the running status.
Er73 Copy without input password	Password is valid and user does not input password.
Er74 Copy between different models	If copy code, or voltage level or power is different, copy is forbidden.
Er75 Copy forbidden	Parameters copy when F638=0

F641 Inhibition gain of low frequency oscillation	0~100 0: Invalid	Subject to inverter model
---	---------------------	---------------------------

F641 is used for setting the inhibition ability of low frequency oscillation.

When F641=0, inhibition function is invalid.

In the V/F control mode, if inhibition of low frequency oscillation is valid, the following parameters are needed to be set.

- (1) F106=2 (V/F control mode) and F137≤2;
- (2) F613=0, the speed track function is invalid.

Note:

1. When F641=1, one inverter can only drive one motor one time.
2. When F641=1, please set motor parameters (F801~F805, F844) correctly.
3. When inhibition oscillation function is invalid, and inverter runs without motor, output voltage may be unbalanced. This is normal situation. After inverter runs with motor, output voltage will be balanced.

F643 Multi-functional key	Setting range: 0: Invalid 1: FWD jogging 2: REV jogging 3: Switchover between local/remote	Mfr's value: 0
---------------------------	--	----------------



For 4-line LCD keypad, set F643 in setting range, press “FUN” to check the operation above is valid or not.

F644 Keypad copy enabled	Setting range: 0: Invalid 1: Current macro parameters upload 2: Current macro parameters download 3: User macro 1 parameters upload 4: User macro 1 parameters download 5: User macro 2 parameters upload 6: User macro 2 parameters download	Mfr's value: 0
--------------------------	--	----------------

Only LCD keypad can support keypad copy, LED keypad cannot support keypad copy.

In stop status, after saving to user macro 1 or 2, set F644=1, then press “RUN” key to enter parameter upload interface, at this time, all current macro parameters will upload into keypad. In a similar way, set F644=3, user macro 1 parameters upload; F644=5, user macro 2 parameters upload. After uploading, set F644=2 to download parameter to current macro and cover current parameters; F644=4: download parameters to user macro 1 and cover the original parameters of user macro 1; In the similar way, F644=6: download parameters to user macro 2 and cover the original parameters of user macro 2.

F645 Status parameters selection	0	Running frequency
	1	Rotation speed
	2	Target speed
	3	Output current
	4	Output voltage
	5	DC bus voltage
	6	PID setting value
	7	PID feedback value
	8	Radiator temperature
	9	Count value
	10	Linear speed
	11	Channel for main frequency
	12	Main frequency
	13	Channel for accessorial frequency
	14	Accessorial frequency
	15	Target frequency
	16	Reserved
	17	Output torque
	18	Setting torque
	19	Motor power
	20	Output power
	21	Running status
	22	DI terminal status
	23	Output terminal status
	24	Stage speed of multi-stage speed
	25	All input value

	26	AI2 input value
	28	Reserved
	29	Pulse input frequency
	30	Pulse output frequency
	31	AO1 output percent
	32	AO2 output percent
	33	Power on Hours

For four-line LCD, the displayed contents at first two lines can be changed by setting F645.

F646 Backlight time of LCD (S)	Setting range: 0~100	Mfr's value: 100
F647 Language selection	Setting range: 0: Chinese 1: English 2: Deutsch 3~10: reserved	Mfr's value: 0

Change the duration of backlight by setting F646. F646=0, LCD light is always off; F646=100, LCD light is always on. Press 1~99 is the duration time of LCD backlight.

Change display language by setting F647, the default value is Chinese.

F657 Instantaneous power failure selection	Setting range: 0: Invalid 1: Reduce frequency 2: slow down to stop	Mfr's value: 0
F658 Voltage rally acceleration time	Setting range: 0.0~3000s 0.0: F114	Mfr's value: 0.0
F659 Voltage rally deceleration time	Setting range: 0.0~3000s 0.0: F115	Mfr's value: 0.0
F660 Action judging voltage at instantaneous power failure (V)	Setting range: 200~F661	Subject to inverter model
F661 Action stop voltage at instantaneous power failure (V)	Setting range: F660~1400	Subject to inverter model
F662 Instantaneous voltage recovery judging time(s)	Setting range: 0.00~10.00	Mfr's value: 0.30

- F657=0, the function of instantaneous power failure is invalid.
- F657=1, when short-time power off or electric dazzling happens, inverter starts to reduce frequency after checking that it satisfies the requirements of instantaneous power failure, and turns kinetic energy to electric energy for maintaining the normal work. Inverter will recover to the former operation status after power resets.
- Upon instantaneous power failure or sudden voltage dip, the DC bus voltage of the inverter reduces. The function enables the inverter to compensate the DC bus voltage reduction with the load feedback energy by reducing the output frequency so as to keep the inverter running continuously.
- F657=2, when satisfying the requirements of instantaneous power failure, inverter starts to reduce frequency, and remain PN voltage as discharge voltage level to make inverter stop quickly. No matter the power resets or not, inverter will stop automatically after slowing down to the min frequency.

Note: The function is suitable for big inertia load, such as, fan and centrifugal pump.

The function is not suitable for the application which frequency is forbidden being decreased.

- When the bus voltage resumes to normal, F658/F659 are used to set the accel/decel time when inverter

runs to target frequency.

- When instantaneous function is valid, if PN voltage is lower than F660, instantaneous function works.
- When inverter is at instantaneous status, if PN voltage is higher than F661, the bus voltage remains to normal, inverter will work normally and run to target frequency.
- F662: Inverter stops decelerating after power resets, and it starts to recover to the status before instantaneous stop after judging time.

The function diagram of Instantaneous power failure:

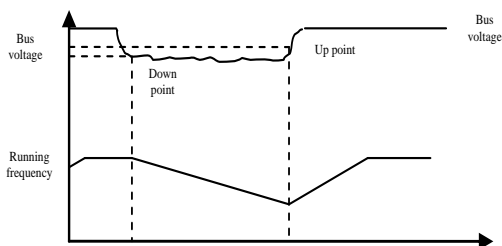

F670 Voltage-limit current-limit adjustment coefficient	Setting range: 0.01~10.00	Mfr's value: 2.00
---	---------------------------	-------------------

Lower this factor properly if frequent over-voltage protection occurs in the process of deceleration; Increase the factor when deceleration is too slow.

F671 voltage source for V/F separation	Setting range: 0: F672 1: AI1 2: AI2 4: Communication setting 5: Pulse setting 6: PID given 7~10: reserved	Mfr's value: 0
F672 Voltage digital setting for V/F separation	Setting range: 0.00~100.00	Mfr's value: 100.0

F671 is 100% of the setting corresponds to the rated motor voltage.

F671=0: Digital setting, the output voltage is set by F672.

F671=1: AI1; F671=2: AI2; the output voltage is set by analog.

F671=4: Communication setting

The output voltage is set by PC/PLC, the communication address is 2009H, the given range is 0~10000, which means 0~100% of rated voltage.

F671=5 pulse setting: The output voltage is set by external high-speed pulse. The input frequency of pulse corresponds to motor rated voltage.

F671=6: PID given: The output voltage is set by PID. PID adjustment corresponds to 100% of motor rated voltage. For details, please refer to PID parameters group.

F671=7~10: Reserved.

F673 Lower limit of voltage at V/F separation (%)	Setting range: 0.00~F633	Mfr's value: 0.00
F674 Upper limit of voltage at V/F separation (%)	Setting range: F632~100.00	Mfr's value: 100.00

When the voltage is lower than F673, the voltage should equal to F673. When the voltage is higher than

F674, the voltage should equal to F674.

F675 Voltage rise time of V/F separation (S)	Setting range: 0.0~3000.0	Mfr's value: 5.0
F676 Voltage decline time of V/F separation (S)	Setting range: 0.0~3000.0	Mfr's value: 5.0

F675 is the time required for the output voltage to rise from 0V to the rated motor voltage.

F676 is the time required for the output voltage to decline from the rated motor voltage to 0V.

F677 Stop mode at V/F separation	Setting range: 0: voltage/frequency declines to 0 according to respective time. 1: Voltage declines to 0 firstly 2: Frequency declines to 0 firstly.	Mfr's value: 0
----------------------------------	---	----------------

When F677 = 0, voltage and frequency declines to 0 according to respective time, inverter will stop when frequency declines to 0.

When F677 = 1, voltage will decline to 0 at first. After voltage is 0, frequency will decline to 0.

When F677 = 2, frequency will decline to 0 at first. After frequency is 0, voltage will decline to 0.

## 5.8. Malfunction and Protection

F700 Selection of terminal free stop mode	Setting range: 0: free stop immediately; 1: delayed free stop	Mfr's value: 0
F701 Delay time for free stop and programmable terminal action	Setting range: 0.0~60.0S	Mfr's value: 0.0

“Selection of free stop mode” can be used only for the mode of “free stop” controlled by the terminal. The related parameters setting is F201=1, 2, 4 and F209=1.

When “free stop immediately” is selected, delay time (F701) will be invalid and inverter will free stop immediately.

“Delayed free stop” means that upon receiving “free stop” signal, the inverter will execute “free stop” command after waiting some time instead of stopping immediately. Delay time is set by F701. During the process of speed track, the function of delayed free stop is invalid.

F702 Fan control mode	0: controlled by temperature 1: Running when inverter is powered on. 2: controlled by running status	Mfr's value: 2
-----------------------	--	----------------

When F702=0, fan will run if radiator's temperature is up to preset temperature.

When F702=2, fan will run when inverter begins running. When inverter stops, fan will stop according to radiator's temperature.

F704 Inverter Overloading pre-alarm Coefficient (%)	Setting range: 50~100	Mfr's value: 80
F705 Motor Overloading pre-alarm Coefficient (%)	Setting range: 50~100	Mfr's value: 80
F706 Inverter Overloading Coefficient (%)	Setting range: 120~190	Mfr's value: 150
F707 Motor Overloading Coefficient (%)	Setting range: 20~100	Mfr's value: 100

· Inverter overloading coefficient: the ratio of overload-protection current and rated current, which value shall be subject to actual load.

· Motor overloading coefficient (F707): when inverter drives lower power motor, please set the value of F707 by below formula in order to protect motor.

Motor Overloading Coefficient= (Actual motor rated current)/(Inverter rated current)\*100%

Please set F707 according to actual situation. The lower the setting value of F707 is, the faster the overload protection speed. Please refer to Fig 5-17.

E.g. 7.5kW inverter(rated current 17A) drives 5.5kW motor(rated current 12A),  $F707=12/17*100\% \approx 70\%$   
When the actual current of motor reaches 140% of inverter rated current, inverter overload protection will display after 1 minute.

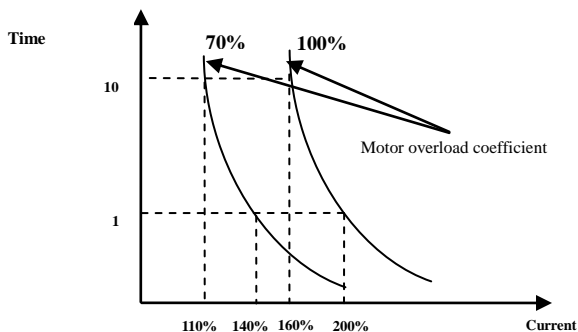
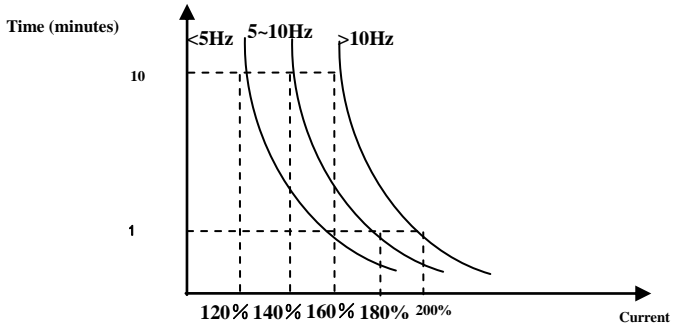

Figure 5-16 Motor overload coefficients

When the output frequency is lower than 10Hz, the heat dissipation effect of common motor will be worse. So when running frequency is lower than 10Hz, the threshold of motor overload value will be reduced. Please refer to Fig 5-20 (F707=100%):



**Figure 5-17 Motor overload protection value**

F708	Record of The Latest Malfunction Type	Setting range: Please refer to Appendix 1.	
F709	Record of Malfunction Type for Last but One		
F710	Record of Malfunction Type for Last but Two		
F711	Fault Frequency of The Latest Malfunction (Hz)		
F712	Fault Current of The Latest Malfunction (A)		
F713	Fault PN Voltage of The Latest Malfunction (V)		
F714	Fault Frequency of Last Malfunction but One(Hz)		
F715	Fault Current of Last Malfunction but One(A)		
F716	Fault PN Voltage of Last Malfunction but One (V)		
F717	Fault Frequency of Last Malfunction but Two(Hz)		
F718	Fault Current of Last Malfunction but Two (A)		
F719	Fault PN Voltage of Last Malfunction but Two (V)		
F720	Record of over current protection fault times		
F721	Record of overvoltage protection fault times		
F722	Record of overheat protection fault times		
F723	Record of overload protection fault times		
F724	Input phase loss	Setting range: 0: invalid; 1: valid	Mfr's value: S2: 0 T2/T3: 1
F725	Under-voltage protection	Setting range: 0: reset manually 1: reset automatically	Mfr's value: 2

F726 Overheat	Setting range: 0: invalid; 1: valid	Mfr's value: 1
F727 Output phase loss	Setting range: 0: invalid; 1: valid	Mfr's value: 1
F728 Input phase loss filtering constant (S)	Setting range: 0.1~60	Mfr's value: 5
F729 Under-voltage filtering constant (2mS)	Setting range: 1~3000	Mfr's value: 5
F730 Overheat protection filtering constant (S)	Setting range: 0.1~60.0	Mfr's value: 5.0
F732 Under-voltage protection voltage threshold	Subject to inverter model	Subject to inverter model

“Under-voltage” refers to too low voltage at AC input side.

“Input phase loss” refers to phase loss of three-phase power supply.

“Output phase loss” refers to phase loss of inverter three-phase wirings or motor wirings.

F737 Over-current 1 protection	Setting range: 0:Invalid 1: Valid	Mfr's value: 1
F738 Over-current 1 protection coefficient	Setting range: 0.50~3.00	Mfr's value: 2.50
F739 Over-current 1 protection record		

·F738= OC 1 value/inverter rated current

·In running status, F738 is not allowed to modify. When over-current occurs, OC1 is displayed

F741 Analog disconnected protection	Setting range: 0: Invalid 1: Stop and AErr displays. 2: Stop and AErr is not displayed. 3: Inverter runs at the min frequency. 4: Reserved.	Mfr's value: 0
F742 Threshold of analog disconnected protection (%)	Setting range: 1~100	Mfr's value: 50

When the values of F400 and F406 are lower than 0.01V, analog disconnected protection is invalid.

When F741 is set to 1, 2 or 3, the values of F400 and F406 should be set to 1V-2V, to avoid the error protection by interference.

Analog disconnected protection voltage=analog channel input lower limit \* F742. Take the AI1 channel for the example, if F400=1.00, F742=50, then disconnection protection will occur when the AI1 channel voltage is lower than 0.5V.

F745 Threshold of pre-alarm overheat (%)	Setting range: 0~100	Mfr's value: 80
F746 Carrier frequency auto-adjusting threshold	Setting range: 60~72	Mfr's value: 65
F747 Carrier frequency auto-adjusting	Setting range: 0:Invalid 1: Valid	Mfr's value: 1

When the temperature of radiator reaches the value of 95°C \* F745 and multi-function output terminal is set to 16 (Please refer to F300~F302), it indicates inverter is in the status of overheat.

When F747=1, the temperature of radiator reaches 86°C, inverter carrier frequency will adjust automatically, to decrease the temperature of inverter. This function can avoid overheat malfunction.

When F159=1, random carrier frequency is selected, F747 is invalid.

F751 Fan runs regularly enabled	Setting range: 0: Disabled 1: Enabled	Mfr's value: 0
---------------------------------	---------------------------------------	----------------

F751=0, the function is disabled.

F751=1, fan will run for 1 minute each 24 hours when power-on to clean the dust around the inverter. If power off, the time will recalculate again when power-on.

F754 Zero-current threshold (%)	Setting range: 0~200	Mfr's value: 5
F755 Duration time of zero-current (S)	Setting range: 0~60.0	Mfr's value: 0.5
When output current is fallen to zero-current threshold, ON signal is output after the duration time of zero-current.		
F756 Voltage limiting power-on detection delay time (ms)	Setting range: 0: No detection 1~5000	Mfr's value: 0
F757 Voltage limiting stop detection delay time (S)	Setting range: 0.0~100.0	Mfr's value: 5.0

F756 voltage limiting detection delay time when power-on.

When F756=0, bus voltage reference when voltage limiting needs no detection; when F756≠0, bus voltage will be detected circularly delaying set time after SD closed.

F757 voltage limiting detection delay time when stop.

After the inverter stops, to prevent that the bus voltage is too high, the inverter will delay for certain time, then make circle detection for bus voltage. The detected value is displayed in HO16

F759 Carrier frequency ratio	Setting range: 3~15	Mfr's value: 7
------------------------------	---------------------	----------------

Carrier frequency=current running frequency\*F759 When the product of current running frequency and frequency ratio is higher than carrier frequency, the actual carrier frequency increases automatically according to the carrier frequency ratio, and also not restricted by the temperature control to lower the carrier frequency.

F760 Grounding protection	Setting range: 0: Invalid 1: Valid	Mfr's value: 1
---------------------------	------------------------------------	----------------

When output terminals (U, V, W) are connected to the earth or the earth impedance is too low, then the leak current is high, inverter will trip into GP. When grounding protection is valid, U, V, W will output voltage for a while after power on. Note: S2 and T2 inverters do not have GP protection.

F761 Switchover mode of FWD/REV	Setting range: 0: At zero 1: at start frequency	Mfr's value: 0
---------------------------------	--	----------------

When F761=0, FWD/REV switches at zero frequency, F120 is valid.

When F761=1, FWD/REV switches at start frequency, F120 is invalid, if start frequency is too high, current shock will occur during switchover process.

F762 Main interface LOGO name	Setting range: A~Z, a~z, 0~9, special character	
F763 Main interface parameter name	Setting range: A~Z, a~z, 0~9, special character	
F764 Main interface parameter unit	Setting range: A~Z, a~z, 0~9, special character	
F765 Main interface parameter coefficient (%)	Setting range: 0.01~200.00	Mfr's value: 100.00

The function of editable main interface parameter can be displayed in the conditions below:

Set F131/F132=0, the function of F762~F765 displays parameter name and editable unit only in the interface of English and German, which means F647=1/2; the editable LOGO name can be displayed in Chinese interface.

F762 main interface LOGO name

Edit LOGO name via UP/DOWN key in the 4<sup>th</sup> line of LCD keypad.

F763 main interface parameter name

Edit the corresponding parameter name of F645 value via UP/DOWN key in the 4<sup>th</sup> line of LCD keypad.

F764 main interface parameter unit

Edit the corresponding parameter unit of F645 value via UP/DOWN key in the 4<sup>th</sup> line of LCD keypad.



### F765 main interface parameter coefficient

Edit the corresponding parameter coefficient of F645 via UP/DOWN key in the 4<sup>th</sup> line of LCD keypad.

**Note:** When editing name or unit, press shift key to move the 4<sup>th</sup> line cursor left, press set key to move the 4<sup>th</sup> line cursor right, the position where cursor blinks can be edited, the character length of name is 21 bit, the character length of unit is 6 bit, after editing, long-press set key for around 3 seconds to save character, and exit the editing interface, then enter into parameter interface. After editing the corresponding name, unit and coefficient of F645=1 parameters, user can set F645=0, 2...to re-edit other parameters' content. If user wants to check the content of F645=1, just set F645=1 to enter main interface, then the current interface will display the edited content which saved before. LOGO name is irrelative to the value of F645, which presents a specific logo for customer, so LOGO name will be saved permanently after editing and storing. If user wants to change current LOGO name, just re-edit F762 and save. At present, special characters supported includes . / : ; ' .

If F645=1, F131=0, F647=1, press RUN key to operate as below, press FUN key to switch interface for checking the edited content. See figure as below:

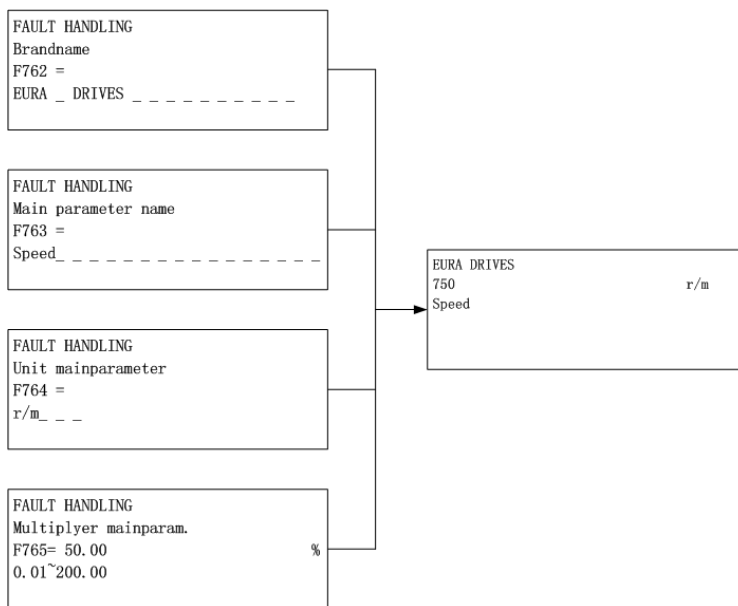

F770 Auxiliary version number	
-------------------------------	--

The auxiliary version number can only be readable, not be modified.

## 5.9. Parameters of the Motor

F800	Motor's parameters tuning	Setting range: 0: Invalid; 1: Rotating tuning; 2: stationary tuning	Mfr's value: 0
F801	Rated power (kW)	Setting range: 0.1~1000.0	Subject to model
F802	Rated voltage (V)	Setting range: 1~1300	
F803	Rated current (A)	Setting range: 0.2~6553.5	
F804	Number of motor poles	Setting range: 2~100	Mfr's value: 4
F805	Rated rotary speed (rpm/min)	Setting range: 1~39000	
F810	Motor rated frequency (Hz)	Setting range: 1.0~650.0	50.00

Please set the parameters in accordance with those indicated on the nameplate of the motor.

Excellent control performance of vector control requires accurate parameters of the motor. Accurate parameter tuning requires correct setting of rated parameters of the motor.

In order to get the excellent control performance, please configure the motor in accordance with adaptable motor of the inverter. In case of too large difference between the actual power of the motor and that of adaptable motor for inverter, the inverter's control performance will decrease remarkably.

F800=0, parameter tuning is invalid. But it is still necessary to set the parameters F801~F803, F805 and F810 correctly according to those indicated on the nameplate of the motor.

After being powered on, it will use default parameters of the motor (see values of F806-F809) according to the motor power set in F801. This value is only a reference value in view of Y series 4-pole induction motor.

F800=1, rotating tuning. In order to ensure dynamic control performance of the inverter, select "rotating tuning" after ensuring that the motor is disconnected from the load. Please set F801-805 and F810 correctly prior to running testing.

Operation process of rotating tuning: Press the "Run" key on the keypad to display "TEST", and it will tune the motor's parameter of two stages. After that, the motor will accelerate according to acceleration time set at F114 and maintain it for a certain period. The motor will then decelerate to 0 according to the time set at F115. After auto-checking is completed, relevant parameters of the motor will be stored in function codes F806~F809, and F800 will turn to 0 automatically.

F800=2, stationary tuning. It is suitable for the cases when it cannot disconnect the motor from the load.

Press the "Run" key, and the inverter will display "TEST", and it will tune the motor's parameter of two stages. The motor's stator resistance, rotor resistance and leakage inductance will be stored in F806-F809 automatically (the motor's mutual inductance uses default value generated according to the power), and F800 will turn to 0 automatically. The user may also calculate and input the motor's mutual inductance value manually according to actual conditions of the motor. With regard to calculation formula and method, please call us for consultation.

When tuning the parameter, motor is not running but powered on. Do not touch motor during this process.

### \*Note:

1. No matter which tuning method of motor parameter is adopted, please set the information of the motor (F801-F805) correctly according to the nameplate of the motor. If the operator is quite familiar with the motor, the operator may input all the parameters (F806-F809) of the motor manually.

2. Parameter F804 can only be checked, not be modified.

3. Incorrect parameters of the motor may result in unstable running of the motor or even failure of normal running. Correct tuning of the parameters is a fundamental guarantee of vector control performance.

Each time when F801 rated power of the motor is changed, the parameters of the motor (F806-F809) will be refreshed to default settings automatically. Therefore, please be careful while amending this parameter.

The motor's parameters may change when the motor heats up after running for a long time. If the load can be disconnected, we recommend auto-checking before each running.

F806	Stator resistance ( $\Omega$ )	Setting range: 0.001~65.53 $\Omega$ (for 15kw and below 15kw) 0.1~6553m $\Omega$ (For above 15kw)	Subject to inverter model
F807	Rotor resistance ( $\Omega$ )	Setting range: 0.001~65.53 $\Omega$ (for 152kw and below 15kw) 0.1~6553m $\Omega$ (For above 15kw)	
F808	Leakage inductance (mH)	Setting range: 0.01~655.3mH (for 15kw and below 15kw) 0.001~65.53mH (for above 15kw)	
F809	Mutual inductance (mH)	Setting range: 0.1~6553mH (for 15kw and below 15kw) 0.01~655.3mH (for above 15 kw)	
F844	Motor no-load current (A)	Setting range: 0.1~F803	

The set values of F806~F809 will be updated automatically after normal completion of parameter tuning of the motor.

The inverter will restore the parameter values of F806~F809 automatically to default standard parameters of the motor each time after changing F801 rated power of the motor;

If it is impossible to measure the motor at the site, input the parameters manually by referring to the known parameters of a similar motor.

Take a 3.7kW inverter for the example: all data are 3.7kW, 400V, 8.8A, 1440rpm/min, 50Hz, and the load is disconnected. When F800=1, the operation steps are as following:

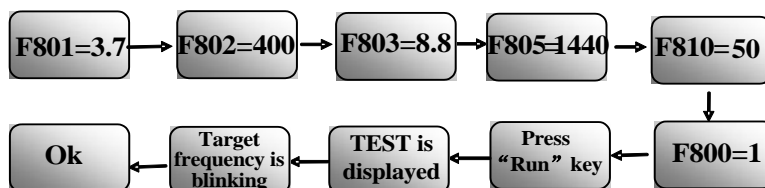

Figure 5-18 Parameter measurement

F812	Pre-exciting time(S)	Setting range: 0.00~30.00	Mfr's value: 0.10
F813	Rotary speed loop KP1	Setting range: 1~100.00	Mfr's value: 30
F814	Rotary speed loop KI1	Setting range: 0.01~10.00	Mfr's value: 0.50
F815	Rotary speed loop KP2	Setting range: 1~100.00	Subject to inverter model
F816	Rotary speed loop KI2	Setting range: 0.01~10.00	Mfr's value: 1.00
F817	PID switching frequency 1(Hz)	Setting range: 0~F818	Mfr's value:5.00
F818	PID switching frequency 2(Hz)	Setting range: F817~F111	Mfr's value:10.00

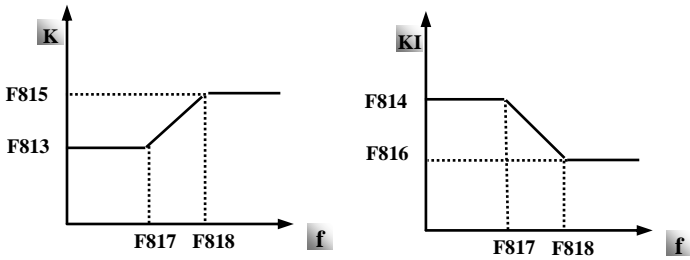

Fig 5-19 PID parameter

Dynamic response of vector control speed can be adjusted through adjusting proportional and storage gains of speed loop. Increasing KP and KI can speed up dynamic response of speed loop. However, if proportional gain or storage gain is too large, it may give rise to oscillation.

Recommended adjusting procedures:

Make fine adjustment of the value on the basis of manufacturer value if the manufacturer setting value can not meet the needs of practical application. Be cautious that amplitude of adjustment each time should not be too large.

In the event of weak loading capacity or slow rising of rotary speed, please increase the value of KP first under the precondition of ensuring no oscillation. If it is stable, please increase the value of KI properly to speed up response.

In the event of oscillation of current or rotary speed, decrease KP and KI properly.

Note: Improper setting of KP and KI may result in violent oscillation of the system, or even failure of normal operation. Please set them carefully.

F819 Slip coefficient	Setting range: 50~200	Mfr's value: 100
F820 Filtering coefficient of speed loop	Setting range: 0~100	Mfr's value: 0

F819 is used to adjust steady speed precision of motor in vector control.

In vector control mode, if speed fluctuation is higher or inverter stops instability, please increase the value of F820 properly; it will influence response speed of speed loop.

F822 Upper limit of speed control torque	Setting range:0.0~250.0	Mfr's value: 200
--	-------------------------	------------------

The parameter of F822 limits the output current in the vector control mode, it also adopts for the open-loop vector, closed-loop vector of synchronous motor and induction motor.

Note: the limited current value is the percentage of motor rated current.

F861 Control mode	Setting range: 0: control mode 1 1: control mode 2	Mfr's value: 0
-------------------	---	----------------

F861=0, control mode 1, this mode is suitable for normal synchronous motor.

F861=1, control mode 2, this mode is suitable for high-frequency synchronous motor.

F862 Frequency switchover point(%)	Setting range: 0.1~50.0	Mfr's value: 5.0
F870 PMSM back electromotive force (mV/rpm)	Setting range: 0.1~6553.0	Mfr's value: 100.0
F871 PMSM D-axis inductance (mH)	Setting range: 0.01~655.30	Mfr's value:5.00
F872 PMSM Q-axis inductance (mH)	Setting range: 0.01~655.30	Mfr's value:7.00
F873 PMSM stator resistance (Ω)	Setting range: 0.001~65.530 (phase resistor)	Mfr's value:0.500

F870(back electromotive force of PMSM, unit = 0.1mV/lrpm, it is back electromotive force value between lines), it is forbidden to revert to Mfr's value by F160.

F871(PMSM D-axis inductance, unit = 0.01 mH), it is forbidden to revert to Mfr's value by F160.

F872(PMSM Q-axis inductance, unit = 0.01 mH), it is forbidden to revert to Mfr's value by F160.

F873(PMSM Stator resistance, unit = m-ohm, 0.001 ohm), it is forbidden to revert to Mfr's value by F160. F870-F873 are motor parameters of PMSM, they are not shown in the motor nameplate. User can get them by auto tuning or asking manufacture.

F876 PMSM injection current without load (%)	Setting range: 0.0~100.0	Mfr's value: 20.0
F877 PMSM injection current compensation without load (%)	Setting range: 0.0~50.0	Mfr's value: 0.0
F878 PMSM cut-off point of injection current compensation without load (%)	Setting range: 0.0~50.0	Mfr's value: 10.0
F879 PMSM injection current with heavy load (%)	Setting range: 0.0~100.0	Mfr's value: 0.0

F876, F877 and F879 are the percent of rated current. F878 is the percent of rated frequency.

E.g.: When F876=20, if F877=10 and F878=0, the injection current without load is 20% of rated current.

When F876=20, if F877=10 and F878=10, and rated frequency is 50Hz, injection current without load will decrease by a linear trend from 30 (F876+F877). When inverter runs to 5Hz (5Hz=rated frequency X F878%), injection current will decrease to 20, and 5Hz is cut-off point of injection current compensation without load.

F880 PMSM PCE detection time (S)	Setting range: 0.1~10.0	Mfr's value: 0.2
----------------------------------	-------------------------	------------------

F880 synchronous motor PCE protection detection time

## 5.10. Communication Parameter

F900 Communication Address	Setting range: 1~255: single inverter address 0: broadcast address	Mfr's value: 1
F901 Communication Mode	Setting range: 1: ASCII 2: RTU	Mfr's value: 2
F902 Stop bit	Setting range: 1~2	Mfr's value: 2
F903 Parity Check	Setting range: 0: Invalid 1: Odd 2: Even	Mfr's value: 0
F904 Baud Rate	Setting range: 0: 1200; 1: 2400; 2: 4800; 3: 9600; 4: 19200 5: 38400 6: 57600	Mfr's value: 3

F904=9600 is recommended for baud rate, which makes run steady.

F905 Communication timeout period (S)	Setting range: 0.0~3000.0	Mfr's value: 0.0
F907 Time 2 of communication timeout (S)	Setting range: 0.0~3000.0	Mfr's value: 0.0

When F905 is set to 0.0, the function is invalid. When  $F905 \neq 0.0$ , if the inverter has not received effective command from PC/PLC during the time set by F905, inverter will trip into CE.

When  $F907 > 0$ , and receiving the previous data, if after the time set by F907, the next data is not received, inverter will output communication timeout signal. The timeout signal will be cleared by this terminal, and after receiving correct data, inverter will accumulate time again.

F911 Master-slave control enabled	0: Disabled 1:Enabled	Mfr's value: 0
-----------------------------------	-----------------------	----------------

When  $F911=0$ , the function is disabled;  $F911=1$ , the function is enabled.

F912 Master/slave selection	Setting range: 0: Master 1:Slave	Mfr's value: 0
-----------------------------	-------------------------------------	----------------

When  $F912=0$ , current inverter is master;  $F912=1$ , current inverter is slave.

F913 Slave running command	Setting range: 0: Slave not follow master running command 1:Slave follow master running command 2: Slave water supply mode	Mfr's value: 1
----------------------------	---	----------------

F913 slave running command: Slave start/stop according to the master's running command.

When  $F913=0$ , slave not follow the master's running command.

$F913=1$ , the slave follows the master to start or stop. Except emergency stop command, please do not send extra start/stop command to slave. If slave stops by keypad, slave will trip into ESP.

When  $F913=2$ , slave water supply mode, this mode is adopted for master-slave control function in constant pressure water supply mode.

F914 Fault information of slave	Setting range: Ones: slave fault information 0: Not sending fault information 1: Sending fault information Tens: master's reaction when it loses slave's response 0: No reaction 1: Alarm	Mfr's value: 01
---------------------------------	--	-----------------

F914 ones: it is used to decide whether to send slave fault information to master.

Tens: when master loses slave's response (must be on-line status), master will trip into Er44.

F915 Master action when slave failed	Setting range: 0: continue running 1: free stop 2: Deceleration to stop	Mfr's value: 1
--------------------------------------	--	----------------

F915 State selection when master receive the signal from the slave failed.

F915=0, if slave failed, master will not be affected and continue running;

F915=1, if slave failed, master free stop;

F915=2, if slave failed, master decelerates to stop.

When F915=1 or 2, after inverter stops, remove the running command between master and slave, after troubleshooting of slave, master can restart again.

F916 Slave action when master stops	Setting range: 1: Free stop 2: Deceleration to stop	Mfr's value: 1
-------------------------------------	--	----------------

When F913=1, F916 is valid.

When F916 = 1, slave will free stop.

When F916 = 2, slave will stop according to deceleration time.

F917 Slave following master command selection	Setting range: 0: given torque(torque) 1: given frequency 1(Droop) 2: given frequency 2 (Droop) 3: slave synchronize in water supply mode	Mfr's value: 0
---	---	----------------

The information type selection of master and slave must be same.

When F917 = 0, it is suitable for rigid connection occasion. Master must run in vector control mode, slave must run at torque control, and the limit speed of slave must be set correctly.

When F917 = 1 and 2, it is suitable for flexible connection occasion. Master and slave will work at speed mode and droop control function is valid. When F917=1, the target frequency is master given frequency.

When F917=2, master given frequency is present frequency (only valid in VVVF control).

When F917=3, the function is enabled in the mode of constant water supply.

Note: When F917=1, 2, suitable for the occasion of flexible connection, master and slave work in speed mode, and droop control function is enabled.

F918 Zero offset of received data (torque)	Setting range:0.00~200.00	Mfr's value: 100.00
F919 Gain of received data(torque)	Setting range:0.00~10.00	Mfr's value: 1.00

F918 and F919 are used to adjust torque received from the master. The adjustment formula is as below:

$$y = F919 * x + F918 - 100.00.$$

When F918=100.00, it means no zero bias.

F920 Zero offset of received data (frequency)	Setting range:0.00~200.00	Mfr's value:100.00
F921 Gain of received data(frequency)	Setting range:0.00~10.00	Mfr's value:1.00

F920 and F921 are used to adjust frequency received from the master. The adjustment formula is as below:  
 $y = F921 * x + F920 - 100.00$

When F920=100.00, it means no zero bias.

F922 window	Setting range: 0.00~10.00	Mfr's value: 0.50
-------------	---------------------------	-------------------

When F917=0, F922 is valid. It is used to limit the slave speed in torque control mode.

F923 Droop control	Setting range: 0.0( Invalid) 0.1~30.0	Mfr's value: 0.0
--------------------	---------------------------------------	------------------

When F917 =1 and 2, droop control is valid when master and slave are both in speed control mode.

Droop control allows tiny speed deviation between master and slave, reasonable droop rate setting needs to be adjusted according to actual situation.

Droop speed= synchronizing frequency \*output torque \* droop rate

inverter actual output frequency = synchronizing frequency – droop speed

For example, when F923 = 7%, synchronizing frequency is 45Hz, output torque is 35%,

Then inverter actual output frequency = 45 - (45 \* 0.35 \* 0.07 ) = 43.90Hz.

F924 Time of communication timeout (S)	Setting range: 0.0~3000.0	Mfr's value: 0.0
--	---------------------------	------------------

when F924=0.0, inverter does not test the timeout.

F925 Master sending data interval (S)	Setting range: 0.000~1.000	Mfr's value: 0.0
F926 CAN baud rate (kbps)	Setting range: 0: 20 1:50 2:100 3:125 4:250 5:500 6:1000	Mfr's value: 6

Please refer to Appendix 7 for master/slave control operation.

F927 Master action when put into slave	Setting range: 0: Stop 1: Remain running	Mfr's value: 1
--	---	----------------

F927=0, master stops when put into slave.

F927=1, master does not stop when put into slave.

F930 Keypad disconnected protection(s)	0: Invalid 0~10: 0~10S	Mfr's value: 0.0
--	---------------------------	------------------

F930 means that the delay time(s) that running inverter freely stops and jump to malfunction when taking out the keypad. Communication parameters refer to Appendix 5.



## 5.11 PID Parameters

### 5.11.1. Internal PID adjusting and constant pressure water supply

Internal PID adjusting control is used for single pump or double pump automatic constant-pressure water supply, or used for simple close-loop system with convenient operation.

The usage of pressure meter:

As FAO2=1: channel AI1

“10V” connect with the power supply of pressure meter, if the power supply of pressure meter is 5V, please supply a 5V power.

“AI1” connect with the pressure signal port of pressure meter

“GND” connect with the grounding of pressure meter

As FAO2=2: channel AI2

“10V” connect with the power supply of pressure meter, if the power supply of pressure meter is 5V, please supply a 5V power.

“AI2” connect with the pressure signal port of pressure meter

“GND” connect with the grounding of pressure meter

For current type sensor, two-line 4-20mA signal is inputted to inverter, Connect CM to GND, and 24V is connected to power supply of sensor.

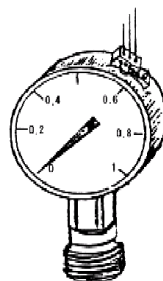

### 5.11.2. Parameters

FA00 Water supply mode	Setting range: 0: Single pump (PID control mode) 1: Fixed mode 2: <u>Timing interchanging</u>	Mfr's value: 0
------------------------	--	----------------

When FA00=0 and single pump mode is selected, the inverter only controls one pump. The control mode can be used in the closed-loop control system, for example, pressure, flow.

When FA00=1, one motor is connected with converter pump or general pump all the time.

When FA00=2, two pumps are interchanging to connect with inverter for a fixed period of time, this function should be selected. The duration time is set by FA25.

FA01 PID adjusting target given source	Setting range: 0: FA04 1: AI1 2: AI2 4: FI (pulse frequency input)	Mfr's value: 0
--	---	----------------

When FA01=0, PID adjusting target is given by FA04 or MODBUS.

When FA01=1, PID adjusting target is given by external analog AI1.

When FA01=2, PID adjusting target is given by external analog AI2.

When FA01=4, PID adjusting target is given by FI pulse frequency (DI1 terminal).

FA02 PID adjusting feedback given source	Setting range: 1: AI1 2: AI2 3: FI (pulse frequency input) 4: Communication given 5: Running current 6: Output power 7: Output torque	Mfr's value: 1
--	--	----------------

When FA02=1, PID feedback signal is given by external analog AI1.

When FA02=2, PID feedback signal is given by external analog AI2.

When FA02=3, PID feedback signal is given by FI pulse frequency input (DI1 terminal).

When FA02=4, Communication gives PID feedback. PC gives PID feedback, address is 2030H, setting range is integer 0~10000, which means 0~100%.

When FA02=5, PID feedback signal is given by inverter running current.

When FA02=6, PID feedback signal is given by inverter output power.

When FA02=7, PID feedback signal is given by inverter output torque.

FA03 Max limit of PID adjusting (%)	Setting range: FA04~100.0	Mfr's value: 100.0
FA04 Digital setting value of PID adjusting (%)	Setting range: FA05~FA03	Mfr's value: 50.0
FA05 Min limit of PID adjusting (%)	Setting range: 0.0~FA04	Mfr's value: 0.0

When negative feedback adjusting is valid, if pressure is higher than max limit of PID adjusting, pressure protection will occur. If inverter is running, it will free stop, and “nP” is displayed. When positive feedback adjusting is valid, if pressure is higher than Max limit, it indicates that feedback pressure is too low, inverter should accelerate or a linefrequency should be added to increase the displacement.

When FA01=0, the value set by FA04 is digital setting reference value of PID adjusting.

When positive feedback adjusting is valid, if pressure is higher than min limit of PID adjusting, pressure protection will occur. If inverter is running, it will free stop, and “nP” is displayed. When negative feedback adjusting, if pressure is higher than min limit, it indicates that feedback pressure is too low, inverter should accelerate or a linefrequency should be added to increase the displacement.

For example: if the range of pressure meter is 0-1.6MPa, then setting pressure is  $1.6*70\%=1.12\text{MPa}$ , and the max limit pressure is  $1.6*90\%=1.44\text{MPa}$ , and the min limit pressure is  $1.6*5\%=0.08\text{MPa}$ .

FA06 PID polarity	Setting range: 0: Positive feedback 1: Negative feedback	Mfr's value: 1
-------------------	---	----------------

When FA06=0, the higher feedback value is, the higher the motor speed is. This is positive feedback.

When FA06=1, the lower the feedback value is, the higher the motor speed is. This is negative feedback.

FA07 Dormancy function selection	Setting range: 0: Valid 1: Invalid	Mfr's value: 1
----------------------------------	---------------------------------------	----------------

When FA07=0, if inverter runs at the min frequency FA09 for a period time set by FA10, inverter will stop.

When FA07=1, the dormancy function is invalid.

FA09 Min frequency of PID adjusting (Hz)	Setting range: MAX (F112, 0.1)~F111	Mfr's value: 5.00
--	--	-------------------

The min frequency is set by FA09 when PID adjusting is valid.

FA10 Dormancy delay time (S)	Setting range: 0~500.0	Mfr's value: 15.0
------------------------------	------------------------	-------------------

When FA07=0, inverter runs at min frequency FA09 for a period time set by FA10, inverter will free stop and enter into the dormancy status, “np” is displayed.

FA11 Wake delay time (S)	Setting range: 0.0~3000	Mfr's value: 3.0
--------------------------	-------------------------	------------------

After the wake delay time, if the pressure is lower than min limit pressure (Negative feedback), inverter will begin running immediately, or else, inverter will be in the dormancy status.

FA12 PID max frequency(Hz)	Setting range: FA09~F111	Mfr's value: 50.00
----------------------------	--------------------------	--------------------

When PID is valid, FA12 is used to set the max frequency.

FA15 Feedback disconnection protection	Setting range: 0: disabled; 1: enabled	Mfr's value: 0
--	---	----------------

FA16 Feedback disconnection protection point	Setting range: 0.00~100.00	Mfr's value: 1.00
--	----------------------------	-------------------

FA17 Feedback disconnection detection time(s)	Setting range: 1.0~10.0	Mfr's value: 5.0
---	-------------------------	------------------

FA15: feedback disconnection protection, this function applies only to the protection judgment that PID channel is disconnected or not when PID adjusting.

FA16: feedback disconnection protection point: the critical point of feedback disconnection protection, inverter trips into PP fault if current feedback value is lower than FA16.

FA17: feedback disconnection detection time, judgment time of feedback disconnection protection and the delay time of feedback disconnection protection fault auto reset.

For example: take A11 channel as feedback source, when A11 feedback voltage is lower than FA16, inverter trips into feedback disconnection protection after delaying FA17; After tripping to protection, if current A11 feedback voltage is higher than FA16, fault resets automatically after delaying FA17.

FA18 Whether PID adjusting target is changed	Setting range: 0: Invalid 1: Valid	Mfr's value: 1
--	------------------------------------	----------------

When FA18=0, PID adjusting target cannot be changed.

FA19 Proportion Gain P	Setting range: 0.00~10.00	Mfr's value: 0.30
FA20 Integration time I (S)	Setting range: 0.1~100.0	Mfr's value: 0.3
FA21 Differential time D (S)	Setting range: 0.0~10.0	Mfr's value: 0.0
FA22 PID sampling period (2mS)	Setting range: 1~500	Mfr's value: 5

Increasing proportion gain, decreasing integration time and increasing differential time can increase the dynamic response of PID closed-loop system. But if P is too high, I is too low or D is too high, system will not be steady.

Recommend adjusting method:

If mfr's value cannot satisfy requirement, fine adjustments can be proceed based on the mfr's value: increase the proportion gain firstly to ensure system not shaking; then reducing integration time to make system have fast response characteristics; if still not meet the requirement, increase differential time to make system overshoot. To avoid system oscillation, setting too big value is not recommended.

FA22 is set as PID adjutor sampling period, which means that the sampling time to feedback value for PID adjutor. The shorter the sampling time is, the faster adjustment speed is. Its basic unit is 2ms. E.g. 1 means sampling period is 2ms; 5 means 10ms.

The following is PID adjusting arithmetic.

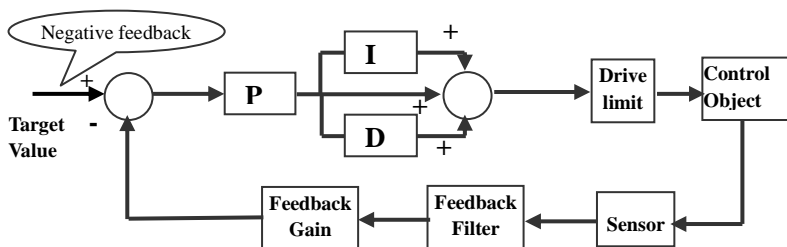

FA23 PID negative frequency output	Setting range: 0: Invalid 1: Valid	Mfr's value: 0
------------------------------------	------------------------------------	----------------

When FA23=1, PID adjutor can output negative frequency.

FA24	Switching Timing unit setting	Setting range: 0: hour 1: minute	Mfr's value: 0
FA25	Switching Timing Setting	Setting range: 1~9999	Mfr's value: 100

Switching time is set by F525. The unit is set by F524.

FA26 Under-load protection mode	Setting Range 0: No protection 1: Protection by contactor 2: Protection by PID 3: Protection by current	Mfr's value: 0
FA27 Current threshold of under-load protection(%)	Setting range: 10~150	Mfr's value: 80
FA66 Duration time of under-load protection (S)	Setting range: 0~60	Mfr's value:20.0

Under-load protection is used to save energy. For some pumps device, when the output power is too low, the efficiency will get worse, so we suggest that the pumps should be closed.

During the running process, if the load decreases to zero suddenly, it means the mechanical part is broken. For example, belt is broken or water pump is dried up. Under-load protection must occur.

When FA26=1, water signal and lack water signal is controlled by two input terminals. When the lack water terminal is valid, inverter will enter into the protection status, and EP1 is displayed. When the water terminal is valid, inverter will deactivate EP1 fault automatically.

When FA26=2, PID adjusting frequency runs to max frequency, if inverter current is lower than the product FA27 and rated current, inverter will enter PID under-load protection status immediately, and EP2 is displayed.

When FA26=3, if inverter current is lower than the product of FA27 and rated current, after duration time of FA66, inverter will enter under-load protection, and “EP3” is displayed.

FA28 Waking time after protection (min)	Setting range: 0~3000	Mfr's value: 60
---	-----------------------	-----------------

After the duration time of FA28, inverter will judge that whether the under-load protection signal disappears. If malfunction is resetted, inverter will run again. Or else inverter will wait until malfunction is resetted. User can reset the inverter by pressing “stop/reset”, inverter will stop.

FA29 PID dead time (%)	Setting range: 0.0~10.0	Mfr's value: 2.0
FA30 Running Interval of restarting converter pump (S)	Setting range:2.0~999.9	Mfr's value: 20.0
FA31 Delay time of starting general pumps (S)	Setting range:0.1~999.9	Mfr's value: 30.0
FA32 Delay time of stopping general pumps (S)	Setting range:0.1~999.9	Mfr's value: 30.0

FA29, PID dead time has two functions. First, setting dead time can restrain PID adjustor oscillation. The greater this value is, the lighter PID adjustor oscillation is. But if the value of FA29 is too high, PID adjusting precision will decrease. For example: when FA29=2.0% and FA04=70, PID adjusting will not invalid during the feedback value from 68 to 72.

FA29 is set to PID dead time when starting and stopping general pumps by PID adjusting. When negative feedback adjusting is valid, if feedback value is lower than value FA04-FA29 (which equal to set value MINUS dead-time value), inverter will delay the set time of FA31, and then start the general pump. If feedback value is higher than value FA04+FA29 (which equal to set value PLUS dead-time value), inverter will delay the set time of FA32, then stop the general pump.

When starting general pump or interchange time is over, inverter will free stop. After starting general pump, inverter will delay the set time of FA30, and restart converter pump.

When inverter drives two pumps and negative feedback adjusting, if the frequency already reach the max value and after the delay time (FA31), the pressure value is still lower than the value, then the inverter will stop output immediately and motor will freely stop. At the same time, the general pump will be started. After the general pump is fully run, if the present pressure is higher than the set value, inverter will low down the output to the min frequency. After delaying the set time (FA32), inverter will stop the general pump and start converter pump.

When inverter drives two pumps and positive feedback adjusting, if the frequency already reach the max value and after the delay time (FA31), the pressure value still higher than the value, then the inverter will stop output immediately and motor will freely stop. At the same time the general pump will be started. After the general pump runs, if the present pressure is lower than the set value, inverter will low down the output to the min frequency. After delaying the set time (FA32), inverter will stop the general pump and start converter pump.

FA33 stop mode when constant pressure water supply	0: free stop 1: deceleration to stop	Mfr's value: 0
--	---	----------------

FA33 is used to set the stop mode after inverter stops converter pump or trips into nP and EP.

FA36	Whether No.1 relay is available	0: unavailable 1: available	Mfr's value: 0
FA37	Whether No.2 relay is available	0: unavailable 1: available	Mfr's value: 0

No 1 relay corresponds to the terminal DO1 in the control PCB, No 2 relay corresponds to the terminal TA/TC.

FA38	Proportional gain Kp2	Setting range: 0.00~10.00	Mfr's value: 0.30
FA39	Integral time Ki2(s)	Setting range: 0.1~100.0	Mfr's value: 0.3
FA40	Derivative time Kd2(s)	Setting range: 0.0~10.0	Mfr's value: 0.0
FA41	PI parameter switch mode	Setting range: 0: no switch 1: reserved 2: auto switch 3: reserved	Mfr's value: 0
FA42	Switch error 1	Setting range: FA05~FA43	Mfr's value: 0.0
FA43	Switch error 2	Setting range: FA42~FA03	Mfr's value: 0.0

FA38~FA40: this set parameter is the 2<sup>nd</sup> set parameter of PID adjusting, can be switching use with 1<sup>st</sup> set PID parameters.

FA41: adjust PID via selecting different switching modes.

When FA41=0, use 1<sup>st</sup> set PID adjusting parameter, as FA19~FA21.

When FA41=2, when current error (the difference value between PID set value and PID feedback value) is higher than FA43, use 2<sup>nd</sup> set PID parameters to adjust; when current error is lower than FA42, use 1<sup>st</sup> PID parameter to adjust; when current error is in the range between switch error 1 and switch error 2, use transiting parameter to adjust.

FA47 The sequence of starting No 1 relay	Setting range: 1~20	Mfr's value: 20
FA48 The sequence of starting No 2 relay	Setting range: 1~20	Mfr's value: 20

The sequence of starting relays is set by FA47~FA48. The setting value of FA47 and FA48 must be different with each other, or else "Err5" is displayed in the keypad.

FA58 Fire pressure given value (%)	Setting range: 0.0~100.0	Mfr's value: 80.0
------------------------------------	--------------------------	-------------------

FA58 is also called second pressure, when the fire control terminal is valid, pressure target value will switch into second pressure value.

FA59 Emergency fire mode	Setting range: 0: Invalid 1: Emergency fire mode 1 2: Emergency fire mode 2	Mfr's value: 0
--------------------------	--	----------------

When emergency fire mode is valid and emergency fire terminal is valid, inverter will be forbidden operating and protecting (When OC and OE protection occur, inverter will reset automatically and start running). And inverter will run at the frequency of FA60 or target frequency until inverter is broken.

Emergency fire mode 1: when the terminal is valid, inverter will run at target frequency.

Emergency fire mode 2: when the terminal is valid, inverter will run at the frequency of FA60.

FA60 Running frequency of emergency fire(Hz)	Setting range: F112~F111	Mfr's value: 50
--	--------------------------	-----------------

When the emergency fire mode 2 is valid and the fire terminal is valid, inverter will run at the frequency set by FA60.

FA62 when emergency fire control terminal is invalid	Setting range: 0: inverter cannot be stopped by manual 1: inverter can be stopped by manual	Mfr's value: 0
--	---	----------------

FA62=0, when emergency fire control terminal (DIX=33) is invalid, before repower on inverter, or reset inverter, inverter cannot be stopped by manual.

FA62=1, when emergency fire control terminal (DIX=33) is invalid, after quitting from emergency fire mode, inverter can be stopped by manual

FA67 Dormancy mode	Setting range: 0: dormancy mode 1 1: dormancy mode 2	Mfr's value: 0
FA68 Given pressure offset 1 (%)	Setting range: 0.0~100.0	Mfr's value: 30.0
FA69 Given pressure offset 2 (%)	Setting range: 0.0~100.0	Mfr's value: 30.0

When FA67=0, inverter will be awoken according to FA03 and FA05.

If FA67=1 and FA06=1, when pressure is higher than target pressure, and PID adjusts to min frequency, inverter will enter into dormancy status after the setting time of FA10. If inverter is in the dormancy status and pressure is lower than target pressure-FA69, inverter will be awoken after wake delay time.

If FA06=0, when pressure is lower than target pressure, and PID adjusts to min frequency, inverter will free stop and enter into dormancy status after the setting time of FA10. If inverter is in the dormancy status, when pressure is higher than target pressure + FA68, inverter will be awoken after weak delay time

## 5.12 Torque control parameters

FC00 Speed/torque control selection	0: Speed control 1: Torque control 2: Terminal switchover	Mfr's value: 0
-------------------------------------	---	----------------

0: speed control. Inverter will run by setting frequency, and output torque will automatically match with the torque of load, and output torque is limited by max torque (set by manufacture.)

1: Torque control. Inverter will run by setting torque, and output speed will automatically match with the speed of load, and output speed is limited by max speed (set by FC23 and FC25). Please set the proper torque and speed limited.

2: Terminal switchover. User can set DIX terminal as torque/speed switchover terminal to realize switchover between torque and speed. When the terminal is valid, torque control is valid. When the terminal is invalid, speed control is valid.

FC02	Torque accel/decel time (S)	Setting range: 0.1~100.0	Mfr's value: 1
------	-----------------------------	--------------------------	----------------

The time is for inverter to run from 0% to 100% of motor rated torque.

FC06	Torque given channel	Setting range: 0: Digital given (FC09) 1: Analog input AI1 2: Analog input AI2 4: Pulse input channel FI 5: Reserved	Mfr's value: 0
------	----------------------	---	----------------

When FC06=4, only DI1 terminal can be selected because only DI1 terminal has the pulse input function.

FC07	Torque given coefficient	0~3.000	3.000
FC09	Torque given command value (%)	0~300.0	100.0

FC07: when input given torque reaches max value, FC07 is the ratio of inverter output torque and motor rated torque. For example, if FC06=1, F402=10.00, FC07=3.00, when AI1 channel output 10V, the output torque of inverter is 3 times of motor rated torque.

FC14	Offset torque given channel	0: Digital given (FC17) 1: Analog input AI1 2: Analog input AI2 4: Pulse input channel FI 5: Reserved	0
FC15	Offset torque coefficient	0~0.500	0.500
FC16	Offset torque cut-off frequency (%)	0~100.0	10.0
FC17	Offset torque command value (%)	0~50.0	10.00

Offset torque is used to output larger start torque which equals to setting torque and offset torque when motor drives big inertia load. When actual speed is lower than the setting frequency by FC16, offset torque is given by FC14. When actual speed is higher than the setting frequency by FC16, offset torque is 0.

When FC14≠0, and offset torque reaches max value, FC15 is the ratio of offset torque and motor rated torque. For example: if FC14=1, F402=10.00 and FC15=0.500, when AI1 channel outputs 10V, offset torque is 50% of motor rated torque.

FC22	Forward speed limited channel	0: Digital given (FC23) 1: Analog input AI1 2: Analog input AI2 4: Pulse input channel FI 5: Reserved	0
FC23	Forward speed limited (%)	Setting range: 0~100.0	10.0

FC24	Reverse speed limited channel	0: Digital given (FC25) 1: Analog input AI1 2: Analog input AI2	0
FC25	Reverse speed limited (%)	Setting range: 0~100.0	10.0

Speed limited FC23/FC25: if given speed reaches max value, they are used to set percent of inverter output frequency and max frequency F111.

FC28	Electric torque limit channel	0: Digital given (FC30) 1: Analog input AI1 2: Analog input AI2 4: Pulse input channel FI 5: Reserved	0
FC29	Electric torque limit coefficient	0~3.000	3.000
FC30	Electric torque limit (%)	0~300.0	200.0
FC33	Braking torque limit channel	0: Digital given (FC35) 1: Analog input AI1 2: Analog input AI2 4: Pulse input channel FI 5: Reserved	0
FC34	Braking torque limit coefficient	0~3.000	3.000
FC35	Braking torque limit (%)	0~300.0	200.0

When motor is in electric status, output torque limit channel is set by FC28, and limit torque is set by FC29.

When motor is in braking status, Braking torque limit channel is set by FC31, and limit torque is set by FC34.

FC48 Torque switchover enabled	Setting range: 0: Invalid 1: Valid	Mfr's value: 0
FC49 Current-limiting point 2 (%)	Setting range: F608~200	Mfr's value:190
FC50 Frequency switchover point 1(Hz)	Setting range: 1.00~FC51	Mfr's value:10.00
FC51 Frequency switchover point 2(Hz)	Setting range: FC51~F111	Mfr's value: 20.00

FC48 is used to limit max torque or max current during running process. In VF and auto torque promotion mode, it is used to limit current, in vector control mode. It is used to limit torque.

FC49 is the percentage of rated current in VF and auto torque promotion mode. FC49 is the percentage of rated torque in vector control mode.

FC50 and FC51 is frequency switchover point when torque or current change. Please see below Fig.



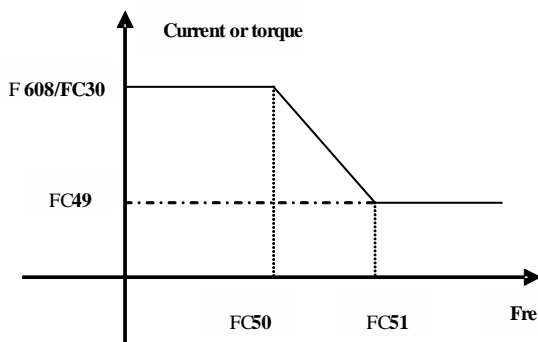

### 5.13 Parameters Display

H000 Running frequency/target frequency(Hz)		
In stopped status, target frequency is displayed. In running status, running frequency is displayed.		
H001 Actual speed/target speed (rpm)		
In stopped status, actual speed is displayed. In running status, target speed is displayed.		
H002 Output current (A)		
In running status, output current is displayed. In stopped status, H002=0.		
H003 Output voltage (V)		
In running status, output voltage is displayed. In stopped status, H003=0.		
H004 Bus voltage (V)		
Bus voltage is displayed by H004.		
H005 PID feedback (%)		
PID feedback value is displayed by H005.		
H006 Temperature (°C)		
Inverter temperature is displayed by H006.		
H007 Count value		
The count value of DI1 input impulse is displayed by H007.		
H008 linear speed		
Inverter linear speed is displayed by H008.		
H009 PID setting value (%)		
PID setting value is displayed by H009.		
H012 Output power (KW)		
Inverter output power is displayed by H012.		
H013 Output torque (%)		
H014 Target torque (%)		
Inverter output torque is displayed by H013 and target torque is displayed by H014.		
H016 Voltage limiting reference value (V)		

Inverter displays current detected voltage-limiting reference value.

H017	Current stage speed for multi-stage speed		
------	---	--	--

In multi-stage speed mode, current stage speed is displayed by H017.

H018	Frequency of input pulse		
------	--------------------------	--	--

Input pulse frequency of DI1 terminal is displayed by H018, the unit is 0.01

H019	Feedback speed (Hz)		
------	---------------------	--	--

Feedback speed is displayed as frequency by H019.

H021	AI1 voltage(digital )		
------	-----------------------	--	--

H022	AI2 voltage( digital )		
------	------------------------	--	--

Analog input voltage is display by H021 and H022.

H025	Current power-on time (minute)		
------	--------------------------------	--	--

H026	Current running time (minute)		
------	-------------------------------	--	--

Current power-on time and running time are displayed by H025 and H026.

H027	Input pulse frequency(Hz)		
------	---------------------------	--	--

Input pulse frequency is displayed by H027, the unit is 1Hz.

H030	Main frequency source X (Hz)		
------	------------------------------	--	--

H031	Accessorial frequency source Y(Hz)		
------	------------------------------------	--	--

Main frequency and accessorial frequency are displayed by H030 and H031.

## Appendix 1 Trouble Shooting

When malfunction occurs to inverter, don't run by resetting immediately. Check any causes and get it removed if there is any.

Take counter measures by referring to this manual in case of any malfunctions on inverter. Should it still be unsolved, contact the manufacturer. Never attempt any repairing without due authorization.

Table 1-1 **Inverter's Common Cases of Malfunctions**

Fault	Description	Causes	Countermeasures
Err0	Prohibition modify function code	* prohibition modify the function code during running process.	* Please modify the function code in stopped status.
Err1	Wrong password	*Enter wrong password when password is valid * Do not enter password when modifying function code.	* Please enter the correct password.
2: O.C.	Over-current	* too short acceleration time * short circuit at output side * locked rotor with motor * Parameter tuning is not correct.	*prolong acceleration time; *whether motor cable is broken; *check if motor overloads; *reduce V/F compensation value * measure parameter correctly.
16: OC1	Over-current 1		
67: OC2	Over-current 2		
3: O.E.	DC Over-Voltage	*supply voltage too high; *load inertia too big *deceleration time too short; *motor inertia rise again *parameter of rotary speed loop PID is set abnormally.	*check if rated voltage is input; *add braking resistance(optional); *increase deceleration time *set the parameter of rotary speed loop PID correctly.
4: P.F1.	Input Phase loss	*phase loss with input power	*check if power input is normal; *check if parameter setting is correct.
5: O.L1	Inverter Overload	* load too heavy	*reduce load; *check drive ratio; *increase inverter's capacity
6: L.U.	Under-Voltage Protection	*input voltage on the low side	*check if supply voltage is normal *check if parameter setting is correct.
7: O.H.	Radiator Overheat	*environment temperature too high; *radiator too dirty *install place not good for ventilation; *fan damaged * Carrier wave frequency or compensation curve is too high.	*improve ventilation; *clean air inlet and outlet and radiator; *install as required; *change fan * Decrease carrier wave frequency or compensation curve.
8: OL2	Motor Overload	* load too heavy	*reduce load; *check drive ratio; *increase motor's capacity
11: ESP	External fault	*External emergency-stop terminal is valid.	*Check external fault.
12: Err3	Current malfunction before running	*Current alarm signal exists before running.	*check if control board is connected with power board well. *ask for help from manufacture.
13: Err2	Parameters tuning wrong	*Do not connect motor when measuring parameters	*please connect motor correctly.
15: Err4	Current zero excursion malfunction	*Flat cable is loosened. *Current detector is broken.	*check the flat cable. *ask for help from manufacture.

17: PF0	Output Phase loss	* Motor is broken * Motor wire is loose. * Inverter is broken	* check if wire of motor is loose. * check if motor is broken.
18: AErr	Line disconnected	* Analog signal line disconnected * Signal source is broken.	* Change the signal line. * Change the signal source.
19: EP3	Inverter under-load	* Water pump dries up. * Belt is broken. * Equipment is broken.	* Supply water for pump * Change the belt. * Repair the equipment.
20: EP/EP2			
22: nP	Pressure control	* Pressure is too high when negative feedback. * Pressure is too low when positive feedback. * Inverter enters into the dormancy status.	* Decrease the min frequency of PID. * Reset inverter to normal status.
23: ERR5	PID parameters are set wrong.	* PID parameters are set wrong.	* Set the parameters correctly.
26: GP	Earth fault protection (1-phase does not have GP protection)	*Motor cable is damaged, short connected to grounding. *Motor isolation is damaged, short connected to grounding. *inverter fault.	*change a new cable. *repair the motor. *contact manufacturer.
27: PG	Encoder fault	*Encoder installation fault *Encoder fault *Encoder line number setting fault	*Check the installation and connection *Check encoder *Setting F851 correctly
32: PCE	PMSM distuning fault	*motor parameters measurement is wrong. *load is too heavy.	* Measure motor parameters correctly. * Decrease the load.
35: OH1	PTC overheat protection	*external relay protection.	*check external heat protection equipment.
44: Er44	Master loses slave's response	*communication fault between master and slave	* check wiring. *check baud rate *check communication parameters setting
45: CE	Communication timeout error	Communication fault	*PC/PLC does not send command at fixed time *Check whether the communication line is connected reliably.
47: EEEP	EEPROM read/write fault	*interference around *EEPROM is damaged.	* remove interferences *contact manufacturer.
49: Err 6	Watchdog fault	Watchdog timeout	*please check watchdog signal
50: oPEn	oPEn protection fault	*oPEn protection terminal disabled	*Check
53: CE 1	Keypad disconnection protection	*Keypad disconnection	*Check communication line

**Table 1-2 Motor Malfunction and Counter Measures**

Malfunction	Items to Be Checked	Counter Measures
Motor not Running	Wiring correct? Setting correct? Too big with load? Motor is damaged? Malfunction protection occurs?	Get connected with power; Check wiring; Clear malfunction; Reduce load; Check against Table 1-1
Wrong Direction of Motor Running	U, V, W wiring correct? Parameters setting correct?	To correct wiring Setting the parameters correctly.
Motor Turning but Speed Change not Possible	Wiring correct for lines with given frequency? Correct setting of running mode? Too big with load?	To correct wiring; To correct setting; Reduce load
Motor Speed Too High or Too Low	Motor's rated value correct? Drive ratio correct? Inverter parameters are set incorrectly? Inverter output voltage is abnormal?	Check motor nameplate data; Check the setting of drive ratio; Check parameters setting; Check V/F Characteristic value
Motor Running Unstable	Too big load? Too big with load change? Phase loss? Motor malfunction.	Reduce load; Reduce load change, increase capacity; Correct wiring.
Power Trip	Wiring current is too high?	Check input wiring; Select matching air switch; Reduce load; Check inverter malfunction.

## Appendix 2 Reference wiring of water system

### 1. Fixed mode of 1 inverter driving 2 pumps

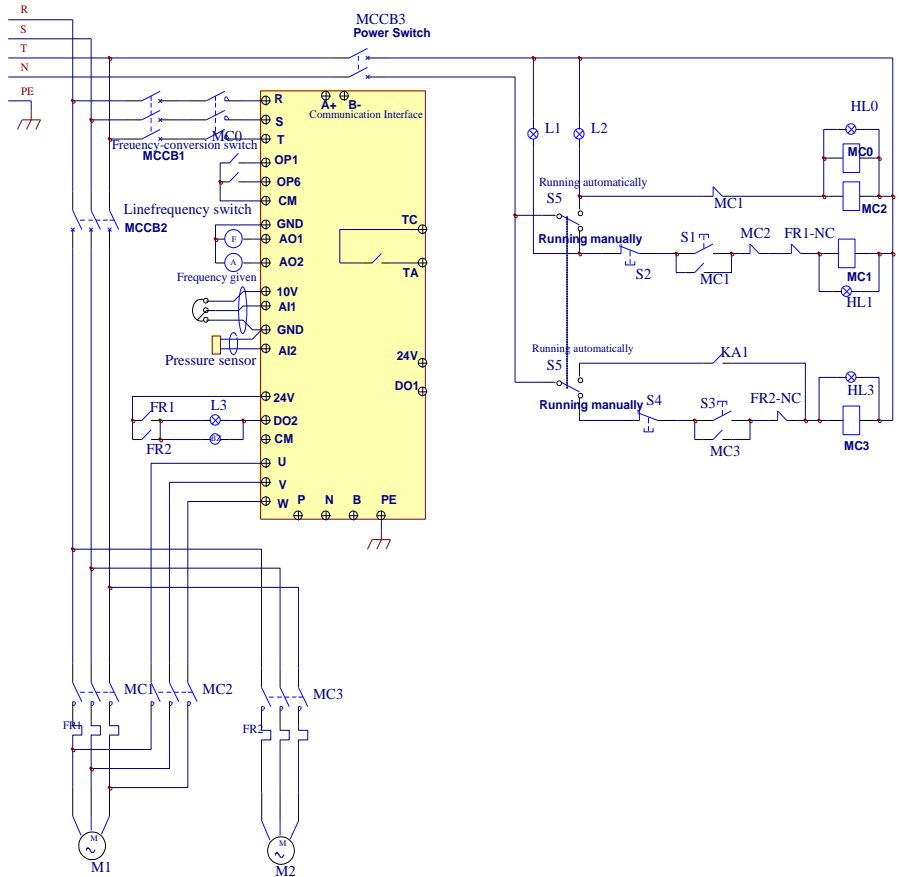

#### Instructions of wiring:

1. Please connect the wiring according to above wiring, after checking the wiring and close MCCB3.
2. Please set F208=1, F203=9, FA00=1, FA36=1, FA47=1, FA48=2, FA04=pressure percentage, FA03=channel limit pressure, and FA05.
3. In manual status, please close power-frequency switch MCCB2. When pressing S1, pump M1 starts working. When pressing S2, M1 stops working. When pressing S3, M2 starts working. When pressing S4, M2 stops working.
4. In automatic status, please close converter-frequency switch MCCB1 and power-frequency switch MCCB2.
  - When inverter is powered on, inverter will run forward by short-connecting DI3 terminal (or run reverse by short-connecting DI4 terminal), M1 will work at power frequency status.

- If the pressure is not high enough, inverter will accelerate to max frequency. If the pressure is still not high enough after duration time FA31, inverter will free stop and pump M2 will start working at power frequency status. After the duration time of FA30, inverter will start working and M1 works at converter frequency status.
- When two pumps work at the same time, if pressure is too high, inverter will decelerate to min frequency. If the pressure is still too high after the duration time FA32, M2 will stop working.
- If one pump M1 works at converter frequency status and inverter works at the min frequency, inverter will free stop after the duration time FA10, inverter will enter into dormancy status and nP is displayed.

## 2. Rotating mode of 1 inverter driving 2 pumps

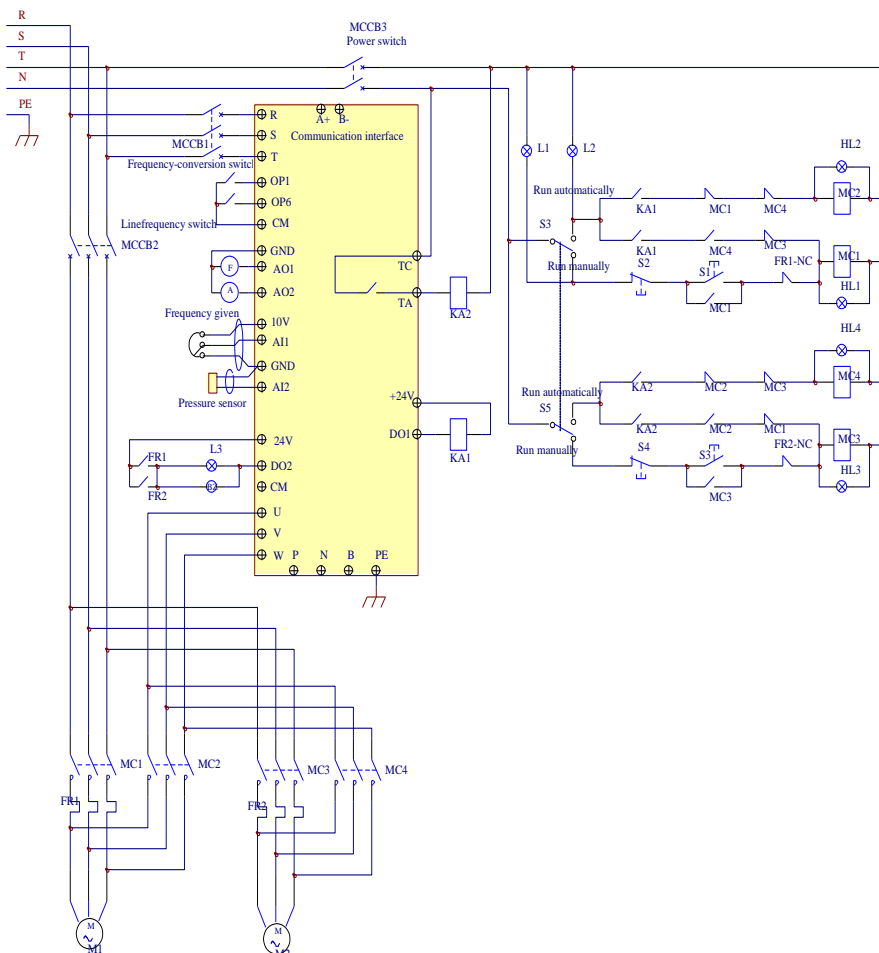

### Instructions of wiring:

1. Please connect the wiring according to above wiring, after checking the wiring and close MCCB3.

2. Please set F208=1, F203=9, FA00=2, FA36=1, FA37=1, FA47=1, FA48=2, FA04=pressure percentage, FA03=channel limit pressure, and FA05
3. In manual status, please close power-frequency switch MCCB2. When pressing S1, pump M1 starts working. When pressing S2, M1 stops working. When pressing S3, M2 starts working. When pressing S4, M2 stops working.
4. In automatic status, please close converter-frequency switch MCCB1 and power-frequency switch MCCB2.
  - When inverter is powered on, KA1 is “action”, and inverter will run forward by short-connecting DI3 terminal, KA2 makes M1 start working at converter frequency status. If the pressure is not high enough, inverter will accelerate to max frequency. If the pressure is still not high enough after duration time FA31, inverter will free stop and pump M2 will start working at power frequency status. After the duration time of FA30, inverter will start working and M1 works at converter frequency status.
  - After the duration time FA25, all pumps will free stop, then KA2 is “action”, M2 is converter pump. If the pressure is not high enough, inverter will accelerate to max frequency. If the pressure is still not high enough after duration time FA31, inverter will free stop and KA1 makes M1 start working at power frequency status. After the duration time of FA30, inverter will start working and M2 works at converter frequency status.
  - When two pumps work at the same time, if pressure is too high, inverter will decelerate to min frequency. If the pressure is still too high after the duration time FA32, general pump will stop working.
  - If one pump works at converter frequency status and inverter works at the min frequency, inverter will free stop after the duration time FA10, inverter will enter into dormancy status and nP is displayed.



## Appendix 3 Products & Structures

EP66 series inverter has its power range between 0.4kW~90kW. Refer to Tables 3-1 and 3-2 for main data. There may be two (or more than two) kinds of structures for certain products. Please make a clear indication when placing your order.

Inverter should operate under the rated output current, with overload permitted for a short time. However, it shall not exceed the allowable values at working time.

Table 3-1 Product List of EP66 series

Model	Applicable Motor (kW)	Rated current Output	Remote keypad	Structure Code	Weight (kg)	Cooling Mode	Remarks
EP66-0004S2I1	0.4	2.5	AD01, AD02, AD03, AD04	I1	6.2	Self-Cooling	Single-Phase Plastic Hanging
EP66-0007S2I1	0.75	4.5		I1	6.2	Self-Cooling	
EP66-0015S2I1	1.5	7		I1	6.2	Self-Cooling	
EP66-0022S2 I1	2.2	10		I1	6.2	Air- Cooling	
EP66-0004T2 I1	0.4	2.5		I1	6.2	Self-Cooling	
EP66-0007T2 I1	0.75	4.5		I1	6.2	Self-Cooling	
EP66-0015T2 I1	1.5	7		I1	6.2	Self-Cooling	
EP66-0022T2 I1	2.2	10		I1	6.2	Air-Cooling	
EP66-0004T3 I1	0.4	1.2		I1	6.2	Self-Cooling	
EP66-0007T3 I1	0.75	2		I1	6.2	Air-Cooling	
EP66-0015T3 I1	1.5	4		I1	6.2	Air- Cooling	
EP66-0022T3 I1	2.2	6.5		I1	6.2	Air- Cooling	
EP66-0030T3 I1	3.0	7		I1	6.2	Air- Cooling	
EP66-0040T3 I1	4.0	9		I1	6.2	Air- Cooling	
EP66-0055T3 I2	5.5	12		I2	8.2	Air- Cooling	
EP66-0075T3 I2	7.5	17		I2	8.2	Air- Cooling	
EP66-0110T3 I3	11	23		I3	11.3	Air- Cooling	
EP66-0150T3 I3	15	32		I3	11.3	Air- Cooling	

EP66-0185T3I4	18.5	38.0	AD01, AD02, AD03 AD04	I4	25	Air- Cooling	Three-Phase Metal Hanging
EP66-0220T3I4	22	44.0		I4	25	Air- Cooling	
EP66-0300T3I4	30	60		I4	25	Air- Cooling	
EP66-0370T3I5	37	75		I5	40	Air- Cooling	
EP66-0450T3I5	45	90		I5	40	Air- Cooling	
EP66-0550T3I5	55	110		I5	40	Air- Cooling	
EP66-0750T3I6	75	150		I6	57	Air- Cooling	
EP66-0900T3I6	90	180		I6	57	Air- Cooling	

**Table 3-2 Structure List**

Structure Code	External Dimension [A×B×H] <sup>note1</sup>	Mounting Size(W×L)	Mounting Bolt	Remarks
I1	200×198×412	171×398	M5	Plastic Housing
I2	242×198×418	215×402	M6	
I3	242×228×471	210×454	M8	
I4	242×324×650	210×624	M8	Metal Housing
I5	308×379×680	272×648	M8	
I6	370×404×770	334×739	M8	

Note 1: the unit is mm.

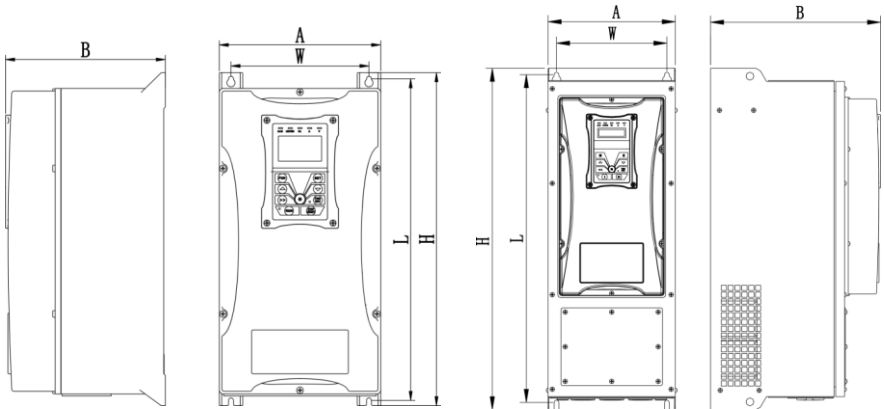

Plastic Profile

Metal Profile

## Appendix 4 Selection of Braking Resistance

Inverter model	Applicable motor power (kW)	Min resistor value ( $\Omega$ )	Min resistor power (W)
EP66-0004S2I1 EP66-0004T2I1	0.4	80 $\Omega$	200W
EP66-0007S2I1 EP66-0007T2I1	0.75		
EP66-0015S2I1 EP66-0015T2I1	1.5		
EP66-0022S2I1 EP66-0022T2I1	2.2		
EP66-0004T3I1	0.4		
EP66-0007T3I1	0.75	80W	
EP66-0015T3I1	1.5	95 $\Omega$	150W
EP66-0022T3I1	2.2	95 $\Omega$	250W
EP66-0030T3I1	3.0	95 $\Omega$	300W
EP66-0040T3I1	4.0	95 $\Omega$	400W
EP66-0055T3I2	5.5	95 $\Omega$	550W
EP66-0075T3I2	7.5	95 $\Omega$	750W
EP66-0110T3I3	11	60 $\Omega$	1.1kW
EP66-0150T3I3	15	35 $\Omega$	1.5kW
EP66-0185T3I4	18.5	35 $\Omega$	2.0kW
EP66-0220T3I4	22	30 $\Omega$	2.2kW
EP66-0300T3I4	30	25 $\Omega$	3.0kW
EP66-0370T3I5	37	25 $\Omega$	4.0kW
EP66-0450T3I5	45	15 $\Omega$	4.5kW
EP66-0550T3I5	55	15 $\Omega$	5.5kW
EP66-0750T3I6	75	12 $\Omega$	7.5kW
EP66-0900T3I6	90	8 $\Omega$	9.0kW

**Note:** in the occasion of large inertia load, if the braking resistor heat is serious, please adopt the larger power of resistor than recommended resistor.

## Appendix 5                      Communication Manual

### (Version 1.8)

## I. General

Modbus is a serial and asynchronous communication protocol. Modbus protocol is a general language applied to PLC and other controlling units. This protocol has defined an information structure which can be identified and used by a controlling unit regardless of whatever network they are transmitted.

You can read reference books or ask for the details of MODBUS from manufactures.

Modbus protocol does not require a special interface while a typical physical interface is RS485.

## II. Modbus Protocol

### 2.1 Transmission mode

#### 2.1.1 Format

##### 1) ASCII mode

Start	Address	Function	Data				LRC check		End	
: (0X3A)	Inverter Address	Function Code	Data Length	Data 1	...	Data N	High-order byte of LRC	Low-order byte of LRC	Return (0X0D)	Line Feed (0X0A)

##### 2) RTU mode

Start	Address	Function	Data	CRC check		End
T1-T2-T3-T4	Inverter Address	Function Code	N data	Low-order byte of CRC	High-order byte of CRC	T1-T2-T3-T4

#### 2.1.2 ASCII Mode

In ASCII mode, one Byte (hexadecimal format) is expressed by two ASCII characters.

For example, 31H (hexadecimal data) includes two ASCII characters '3(33H)', '1(31H)'.

Common characters, ASCII characters are shown in the following table:

Characters	'0'	'1'	'2'	'3'	'4'	'5'	'6'	'7'
ASCII Code	30H	31H	32H	33H	34H	35H	36H	37H
Characters	'8'	'9'	'A'	'B'	'C'	'D'	'E'	'F'
ASCII Code	38H	39H	41H	42H	43H	44H	45H	46H

#### 2.1.3 RTU Mode

In RTU mode, one Byte is expressed by hexadecimal format. For example, 31H is delivered to data packet.

### 2.2 Baud rate

Setting range of EP66 series: 1200, 2400, 4800, 9600, 19200, 38400, 57600

## 2.3 Frame structure:

### 1) ASCII mode

Byte	Function
1	Start Bit (Low Level)
7	Data Bit
0/1	Parity Check Bit (None for this bit in case of no checking. Otherwise 1 bit)
1/2	Stop Bit (1 bit in case of checking, otherwise 2 bits)

### 2) RTU mode

Byte	Function
1	Start Bit (Low Level)
8	Data Bit
0/1	Parity Check Bit (None for this bit in case of no checking. Otherwise 1 bit)
1/2	Stop Bit (1 bit in case of checking, otherwise 2 bits)

## 2.4 Error Check

### 2.4.1 ASCII mode

Longitudinal Redundancy Check (LRC): It is performed on the ASCII message field contents excluding the 'colon' character that begins the message, and excluding the CRLF pair at the end of the message.

The LRC is calculated by adding together successive 8-bit bytes of the message, discarding any carries, and then two's complementing the result.

A procedure for generating an LRC is:

1. Add all bytes in the message, excluding the starting 'colon' and ending CRLF. Add them into an 8-bit field, so that carries will be discarded.
2. Subtract the final field value from FF hex (all 1's), to produce the ones-complement.
3. Add 1 to produce the two-complement.

### 2.4.2 RTU Mode

Cyclical Redundancy Check (CRC): The CRC field is two bytes, containing a 16-bit binary value.

The CRC is started by first preloading a 16-bit register to all 1's. Then a process begins of applying successive 8-bit bytes of the message to the current contents of the register. Only the eight bits of data in each character are used for generating the CRC. Start and stop bits, and the parity bit, do not apply to the CRC.

A procedure for generating a CRC-16 is:

- (1) Load a 16-bit register with FFFF hex (all 1's). Call this the CRC register.
- (2) Exclusive OR the first 8-bit byte of the message with the high-order byte of the 16-bit CRC register, putting the result in the CRC register.
- (3) Shift the CRC register one bit to the right (toward the LSB), zero-filling the MSB. Extract and examine the LSB.
- (4) (If the LSB was 0): Repeat Step 3 (another shift).
- (5) (If the LSB was 1): Exclusive OR the CRC register with the polynomial value A001 hex (1010 0000 0000 0001).
- (6) Repeat Steps 3 and 4 until 8 shifts have been performed. When this is done, a complete 8-bit byte will have been processed.
- (7) When the CRC is appended to the message, the low-order byte is appended first, followed by the high-order byte.

## 2.4.3 Protocol Converter

It is easy to turn a RTU command into an ASCII command followed by the lists:

- 1) Use the LRC replacing the CRC.
- 2) Transform each byte in RTU command into a corresponding two byte ASCII. For example: transform 0x03 into 0x30, 0x33 (ASCII code for 0 and ASCII code for 3).
- 3) Add a 'colon' ( : ) character (ASCII 3A hex) at the beginning of the message.
- 4) End with a 'carriage return – line feed' (CRLF) pair (ASCII 0D and 0A hex).

So we will introduce RTU Mode in followed part. If you use ASCII mode, you can use the up lists to convert.

## 2.5 Command Type & Format

### 2.5.1 The listing below shows the function codes.

code	name	description
03	Read Holding Registers	Read the binary contents of holding registers in the slave. (Less than 10 registers once time )
06	Preset Single Register	Preset a value into holding register

### 2.5.2 Address and meaning

The part introduces inverter running, inverter status and related parameters setting.

Description of rules of function codes parameters address:

- 1) Use the function code as parameter address

General Series:

High-order byte: 01~0A (hexadecimal)

Low-order byte: 00~50 (max range) (hexadecimal) Function code range of each partition is not the same.

The specific range refers to manual.

For example: Parameter address of F114 is 010E (hexadecimal).

Parameter address of F201 is 0201 (hexadecimal).

For H section, please convert H0 to 43.

For example: the address of H014 is 430E.

Note: in this situation, it allows to read six function codes and write only one function code.

Some function codes can only be checked but cannot be modified; some function codes can neither be checked nor be modified; some function codes can not be modified in run state; some function codes cannot be modified both in stop and run state.

In case parameters of all function codes are changed, the effective range, unit and related instructions shall refer to user manual of related series of inverters. Otherwise, unexpected results may occur.

- 2) Use different parameters as parameter address

(The above address and parameters descriptions are in hexadecimal format, for example, the decimal digit 4096 is represented by hexadecimal 1000).

## 1. Running status parameters

Parameters Address	Parameter Description (read only)
1000	Output frequency
1001	Output voltage
1002	Output current
1003	Pole numbers/ control mode, high-order byte is pole numbers, low-order byte is control mode.
1004	Bus-line voltage
1005	<p>Drive ratio/inverter status            High-order byte is drive ratio, low-order byte is inverter status            Inverter status:</p> <p>0X00: Standby mode                      0X01: Forward running            0X02: Reverse running                0X04: Over-current (OC)            0X05: DC over-current (OE)        0X06: Input Phase loss (PF1)            0X07: Frequency Over-load (OL1)   0X08: Under-voltage (LU)            0X09: Overheat (OH)                0X0A: Motor overload (OL2)            0X0B: Interference (Err)            0X0C: LL            0X0D: External Malfunction (ESP)   0X0E: Err3   0X0F: Err2            0X11: Err4   0X12: OC1   0X13:PF0            0X14: Analog disconnected protection (AErr)   0X15: EP3            0X16:Under-load protection (EP)   0X17: PP            0X18: Pressure control protection (nP)            0X19: PID parameters are set incorrectly (Err5)            0X22: PMSM distuing fault (PCE) 0X2F: Communication timeout(CE)            0X33: Watchdog (Err6)   0X34: oPeN fault            0X35: Keypad disconnection protection (CE1)            0X36: STO                      0X48: STO1</p>
1006	The percent of output torque
1007	Inverter radiator temperature
1008	PID given value
1009	PID feedback value
100A	Read integer power value: PC/PLC read integer of power value, discarding the decimal parts.
100B	DI terminal status: DI1~DI8—bit0~bit7
100C	<p>Terminal output status :</p> <p>bit0-OUT1            bit1-OUT2(&gt;15kw)            bit2-fault relay</p>
100D	A11: 0~4095    read input analog digital value
100E	A12: 0~4095    read input analog digital value
1010	Reserved
1011	0~100.00%    the percent of input pulse
1012	0~100.00%    the percent of output pulse
1013	<p>Monitoring in which stage speed inverter is.</p> <p>0000 : no function                      0001 : stage speed 1            0010 : stage speed 2                    0011 : stage speed 3</p>

	0100 : stage speed 4	0101 : stage speed 5
	0110 : stage speed 6	0111 : stage speed 7
	1000 : stage speed 8	1001 : stage speed 9
	1010 : stage speed 10	1011 : stage speed 11
	1100 : stage speed 12	1101 : stage speed 13
	1110 : stage speed 14	1111 : stage speed 15
1014	Monitoring external counting value	
1015	Monitoring analog output percent, AO1 (0~100.00)	
1016	Monitoring analog output percent, AO2 (0~100.00)	
1017	Monitoring current speed.	
1018	Read accurate power value, and correct the power to 1 decimal place.	
101A	Output current(when the current is too high, data overflow from 1002)	
	101A: high 16 bits of output current	
101B	101B: low 16 bits of output current	

## 2. Control command address:

Address	Parameters Description (write only)
2000	Command meaning: 0001: Forward running (no parameters) 0002: Reverse running (no parameters) 0003: Deceleration stop 0004: Free stop 0005: Forward jogging start 0006: Forward jogging stop 0007: Reserved 0008: Run (no directions) 0009: Fault reset 000A: Forward jogging stop 000B: Reverse jogging stop 000C: Wakeup
2001	Lock parameters 0001: Relieve system locked (remote control locked) 0002: Lock remote control (any remote control commands are invalid before unlock) 0003: RAM and EEPROM are permitted to be written. 0004: Only RAM is permitted to be written, EEPROM is prohibited being written.
2002	AO1 output percent is set by PC/PLC. Setting range: 0~1000 Token output analog is 0~100.0%.
2003	AO2 output percent is set by PC/PLC. Setting range: 0~1000 Token output analog is 0~100.0%.
2004	FO output percent is set by PC/PLC. Setting range: 0~1000 FO token output pulse is 0~100.0%.
2005	To control multi-function output terminal:
2006	1 means token output is valid.
2007	0 means token output is invalid.
2009	Voltage is set by PC/PLC when V/F separation.
2030	PID feedback setpoint

Note: Write RAM only allowed when leave factory. Unlock (2001=0003 or F219=0) if changing EEPROM.



### 3. Illegal Response When Reading Parameters

Command Description	Function	Data
Slave parameters response	The highest-order byte changes into 1.	Command meaning: 0001: Illegal function code 0002: Illegal address 0003: Illegal data 0004: Slave fault <sup>note 2</sup>

Note: Illegal response 0004 appears in two cases below:

1. Do not reset inverter when inverter is in the malfunction state.
2. Do not unlock inverter when inverter is in the locked state.

#### Expressions during communication process:

Parameter Values of Frequency=actual value X 100 (General Series)

Parameter Values of Frequency=actual value X 10 (Medium Frequency Series)

Parameter Values of Time=actual value X 10

Parameter Values of Current=actual value X 10

Parameter Values of Voltage=actual value X 1

Parameter Values of Power=actual value X 100

Parameter Values of Drive Ratio=actual value X 100

Parameter Values of Version No. =actual value X 100

Instruction: Parameter value is the value sent in the data package. Actual value is the actual value of inverter.

After PC/PLC receives the value, it will divide the corresponding coefficient to get the actual value.

NOTE: Take no account of radix point of the data in the data package when PC/PLC transmits command to inverter. The valid value is range from 0 to 65535.

### III Function Codes Related to Communication

F200	Source of start command	0: Keypad command; 1: Terminal command; 2: Keypad+Terminal; 3:MODBUS; 4: Keypad+Terminal+MODBUS	4
F201	Source of stop command	0: Keypad command; 1: Terminal command; 2: Keypad+Terminal; 3:MODBUS; 4: Keypad+Terminal+MODBUS	4
F203	Main frequency source X	0: Digital setting memory; 1: External analog AI1; 2: External analog AI2; 3: Pulse input given; 4: Stage speed control; 5: No memory by digital setting 7, 8: Reserved 9: PID adjusting 10:Modbus	0
F900	Inverter Address	1~255: single inverter address 0: Broadcast address	1
F901	Modbus Mode Selection	1: ASCII mode 2: RTU mode	2
F903	Parity Check	0: Invalid 1: Odd 2: Even	0
F904	Baud Rate	0: 1200 1: 2400 2: 4800 3: 9600 4: 19200 5:38400 6: 57600	3

Please set functions code related to communication consonant with the PLC/PC communication parameters, when inverter communicates with PLC/PC.

## IV Physical Interface

### 4.1 Interface instruction

Communication interface of RS485 is located on the most left of control terminals, marked with A+ and B-.

### 4.2 Structure of Field Bus

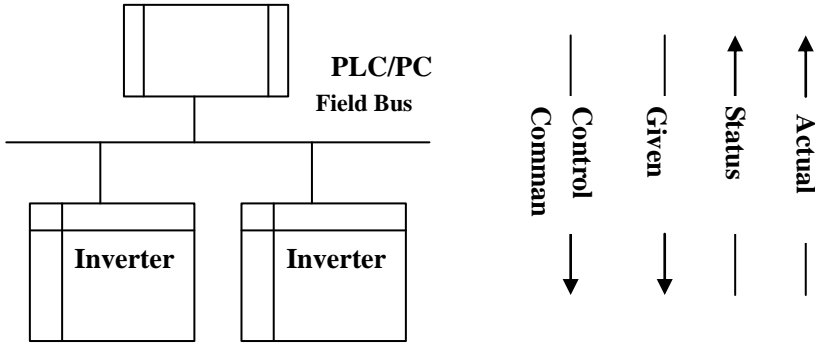

Connecting Diagram of Field Bus

RS485 Half-duplex communication mode is adopted for EP66 series inverter. Daisy chain structure is adopted by 485 Bus-line. Do not use 'spur' lines or a star configuration. Reflect signals which are produced by spur lines or star configuration will interfere in 485 communications.

Please note that for the same time in half-duplex connection, only one inverter can have communication with PC/PLC. Should two or more than two inverters upload data at the same time, then bus competition will occur, which will not only lead to communication failure, but higher current to certain elements as well.

### 4.3 Grounding and Terminal

Terminal resistance of 120 ohm will be adopted for terminal of RS485 network, to diminish the reflection of signals. Terminal resistance shall not be used for intermediate network.

No direct grounding shall be allowed for any point of RS485 network. All the equipment in the network shall be well grounded via their own grounding terminal. Please note that grounding wires will not form closed loop in any case.

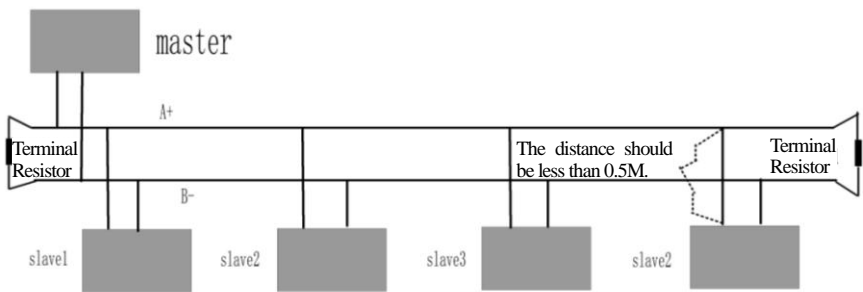

Connecting Diagram of Terminal Resistance

Please think over the drive capacity of PC/PLC and the distance between PC/PLC and inverter when wiring. Add a repeaters if drive capacity is not enough.



**All wiring connections for installation shall have to be made when the inverter is disconnected from power supply.**

## V. Examples

**Eg1:** In RTU mode, change acc time (F114) to 10.0s in NO.01 inverter.

### Query

Address	Function	Register Address Hi	Register Address Lo	Preset Data Hi	Preset Data Lo	CRC Lo	CRC Hi
01	06	01	0E	00	64	E8	1E

**Function code F114 Value: 10.0S**

### Normal Response

Address	Function	Register Address Hi	Register Address Lo	Response Data Hi	Response Data Lo	CRC Lo	CRC Hi
01	06	01	0E	00	64	E8	1E

**Function code F114 Normal Response**

### Abnormal Response

Address	Function	Abnormal code	CRC Lo	CRC Hi
01	86	04	43	A3

**The max value of function code is 1. Slave fault**

**Eg 2:** Read output frequency, output voltage, output current and current rotate speed from N0.2 inverter.

### Host Query

Address	Function	First Register Address Hi	First Register Address Lo	Register count Hi	Register count L0	CRC Lo	CRC Hi
02	03	10	00	00	04	40	FA

**Communication Parameters Address 1000H**

### Slave Response:

Address	Function	Byte Count	Data Hi	Data Lo	Data Hi	Data Lo	Data Hi	Data Lo	Data Hi	Data Lo	Crc Lo	Crc Hi
02	03	08	13	88	01	90	00	3C	02	00	82	F6

**Output Frequency Output Voltage Output Current Numbers of Pole Pairs Control Mode**

**NO.2 Inverter's output frequency is 50.00Hz, output voltage is 400V, output current is 6.0A, numbers of pole pairs are 2 and control mode keypad control.**

**Eg 3:** NO.1 Inverter runs forwardly.

### Host Query:

Address	Function	Register Hi	Register Lo	Write status Hi	Write status Lo	CRC Lo	CRC Hi
01	06	20	00	00	01	43	CA

**Communication parameters address 2000H Forward running**

**Slave Normal Response:**

Address	Function	Register Hi	Register Lo	Write status Hi	Write status Lo	CRC Lo	CRC Hi
01	06	20	00	00	01	43	CA

**Normal Response****Slave Abnormal Response:**

Address	Function	Abnormal Code	CRC Lo	CRC Hi
01	86	01	83	A0

The max value of function code is 1. Illegal function code (assumption)

Eg4: Read the value of F113, F114 from NO.2 inverter

**Host Query:**

Address	Function	Register Address Hi	Register Address Lo	Register Count Hi	Register Count L0	CRC Lo	CRC Hi
02	03	01	0D	00	02	54	07

Communication Parameter Address F10DH

Numbers of Read Registers

**Slave Normal Response:**

Address	Function	Byte count	The first parameters status Hi	The first parameters status Lo	The second parameters status Hi	The second parameters status Lo	CRC Lo	CRC Hi
02	03	04	03	E8	00	78	49	61

The actual value is 10.00.

The actual value is 12.00.

**Slave Abnormal Response:**

Address	Function Code	Abnormal Code	CRC Lo	CRC Hi
02	83	01	70	F0

The max value of function code is 1.

Parity check fault

## Appendix 6 Zoom Table of Function Code

### Basic parameters: F100-F160

Function Code	Function Definition	Setting Range	Mfr's Value	Change
F100	User's Password	0~9999	0	√○
F102	Inverter's Rated Current (A)		Subject to inverter model	△○
F103	Inverter Power (kW)		Subject to inverter model	△○
F104	Reserved			
F105	Software Edition No.	1.00~10.00	Subject to inverter model	△○
F106	Control mode	0: Sensorless vector control (SVC); 2: V/F control; 3: Vector control 1 4,5: Reserved; 6: PMSM sensorless vector control	2	×
F107	Password Valid or Not	0: invalid; 1: valid	0	√
F108	Setting User's Password	0~9999	8	√
F109	Starting Frequency (Hz)	0.0~10.00	0.00	√
F110	Holding Time of Starting Frequency (S)	0.0~999.9	0.0	√
F111	Max Frequency (Hz)	F113~650.0	50.00	×
F112	Min Frequency (Hz)	0.00Hz~F113	0.50	√
F113	Target Frequency (Hz)	F112~F111	50.00	√
F114	1 <sup>st</sup> Acceleration Time (S)	0.1~3000	subject to inverter model	√
F115	1 <sup>st</sup> Deceleration Time (S)	0.1~3000		√
F116	2 <sup>nd</sup> Acceleration Time (S)	0.1~3000		√
F117	2 <sup>nd</sup> Deceleration Time (S)	0.1~3000		√
F118	Turnover Frequency (Hz)	15.00~650.0	50.00	×
F119	Reference of setting accel/decel time	0: 0~50.00 1: 0~max frequency	0	×
F120	Forward/Reverse Switchover dead-Time	0.0~3000	0.0	√
F122	Reverse Running Forbidden	0: invalid; 1: valid	0	×
F123	Minus frequency is valid in the mode of combined speed control.	0: Invalid; 1: valid	0	×
F124	Jogging Frequency	F112~F111	5.00	√
F125	Jogging Acceleration Time	0.1~3000S	subject to inverter model	√
F126	Jogging Deceleration Time	0.1~3000S		√

F127	Skip Frequency A (Hz)	0.00~650.0	0.00	√
F128	Skip Width A(Hz)	0~2.50	0.00	√
F129	Skip Frequency B(Hz)	0.00~650.0	0.00	√
F130	Skip Width B(Hz)	0~2.50	0.00	√
F131	Running Display Items	0— Present output frequency / function code 1— Current output rotary speed 2— Output current 4— Output voltage 8— PN voltage 16— PID feedback value 32— Temperature 64— Count values 128— Linear speed 256— PID given value 2048— Output power 4096— Output torque	$0+1+2+4+8=15$	√
F132	Display items of stop	0: frequency / function code 2: Target rotary speed 4: PN voltage 8: PID feedback value 16: Temperature 32: Count values 64: PID given value 512: Setting torque	$2+4=6$	√
F133	Drive Ratio of Driven System	0.10~200.0	1.0	√
F134	Transmission-wheel radius	0.001~1.000 (m)	0.001	√
F135	User's macro storage	0: disabled 1: Save to user's macro 1 2: Save to user's macro 2	0	×○
F136	Slip compensation (%)	0~10	0	×
F137	Modes of torque compensation	0: Linear compensation; 1: Square compensation; 2: User-defined multipoint compensation 3: Auto torque compensation 4: V/F separation	0	×
F138	Linear compensation	1~20	subject to inverter model	×
F139	Square compensation	1: 1.5;      2: 1.8; 3: 1.9;      4: 2.0 5: Reserved	1	×
F140	Voltage compensation point frequency (Hz)	0.00~F142	1.00	×
F141	Voltage compensation point 1 (%)	0~30	0	×
F142	User-defined frequency point 2 (Hz)	F140~F144	5.00	×

F143	User-defined voltage point 2(%)	0~100	13	×
F144	User-defined frequency point 3 (Hz)	F142~F146	10.00	×
F145	User-defined voltage point 3(%)	0~100	24	×
F146	User-defined frequency point 4 (Hz)	F144~F148	20.00	×
F147	User-defined voltage point 4(%)	0~100	45	×
F148	User-defined frequency point 5 (Hz)	F146~F150	30.00	×
F149	User-defined voltage point 5(%)	0~100	63	×
F150	User-defined frequency point 6 (Hz)	F148~F118	40.00	×
F151	User-defined voltage point 6(%)	0~100	81	×
F152	Output voltage corresponding to turnover frequency	0~100	100	×
F153	Carrier frequency setting	Subject to inverter model	Subject to inverter model	×
F154	Automatic voltage rectification	Setting range: 0: Invalid 1: Valid 2:Invalid during deceleration process	0	×
F155	Digital accessorial frequency setting	0~F111	0	×
F156	Digital accessorial frequency polarity	0~1	0	×
F157	Reading accessorial frequency			△○
F158	Reading accessorial frequency polarity			△○
F159	Random carrier-wave frequency selection	0: Control speed normally (Prohibited); 1: Random carrier-wave frequency(allowed)	0	×
F160	Reverting to manufacturer values	0: Not reverting to manufacturer values 1: Reverting to manufacturer values 10: Revert to manufacturer value for Europe 21: Revert to user macro 1 22: Revert to user macro 2	0	×

**Running control mode: F200-F280**

Function Code	Function Definition	Setting Range	Mfr's Value	Change
F200	Source of start command	0: Keypad command; 1: Terminal command; 2: Keypad+Terminal; 3:MODBUS; 4: Keypad+Terminal+MODBUS	4	×
F201	Source of stop command	0: Keypad command; 1: Terminal command; 2: Keypad+Terminal; 3:MODBUS; 4: Keypad+Terminal+MODBUS	4	×
F202	Mode of direction setting	0: Forward running locking; 1: Reverse running locking; 2: Terminal setting 3: Keypad	0	×
F203	Main frequency source X	0: Digital setting memory; 1: External analog AI1; 2: External analog AI2; 3: Pulse input given; 4: Stage speed control; 5: No memory by digital setting; 7, 8: Reserved; 9: PID adjusting; 10: MODBUS	0	×
F204	Accessorial frequency source Y	0: Digital setting memory; 1: External analog AI1; 2: External analog AI2; 3: Pulse input given; 4: Stage speed control; 5: PID adjusting;	0	×
F205	Reference for selecting accessorial frequency source Y range	0: Relative to max frequency; 1: Relative to main frequency X	0	×
F206	Accessorial frequency Y range (%)	0~100	100	×
F207	Frequency source selecting	0: X; 1: X+Y; 2: X or Y (terminal switchover, Y is prior to X when not switchover); 3: X or X+Y (terminal switchover); 4: Combination of stage speed and analog 5: X-Y 6: X+Y-Y <sub>MAX</sub> *50% 7: Combination of stage speed and digit 1	0	×



F208	Terminal two-line/three-line operation control	0: No function; 1: Two-line operation mode 1; 2: Two-line operation mode 2; 3: three-line operation mode 1; 4: three-line operation mode 2; 5: start/stop controlled by direction pulse	0	×
F209	Selecting the mode of stopping the motor	0: stop by deceleration time; 1: free stop 2: Stop by DC braking	0	×
F210	Frequency display accuracy	0.01~2.00	0.01	√
F211	Speed of digital control (Hz/S)	0.01~100.00	5.00	√
F212	Direction memory	0: Invalid 1: Valid	0	√
F213	Auto-starting after repowered on	0: invalid; 1: valid	0	√
F214	Auto-starting after reset	0: invalid; 1: valid	0	√
F215	Auto-starting delay time	0.1~3000.0	60.0	√
F216	Times of auto-starting in case of repeated faults	0~5	0	√
F217	Delay time for fault reset	0.0~10.0	3.0	√
F218	Reserved			
F219	EEPROM write operation	0:enabled to write 1:prohibit writing	1	√○
F220	Frequency memory after power-down	0: invalid; 1: valid	0	√
F221	Reserved			
F222	count memory selection	Setting range: 0: Invalid 1: Valid	0	√
F223	main frequency coefficient	0.0~100.0	100.0	√
F224	When target frequency is lower than Min frequency	0: stop 1: run at min frequency	0	×
F229	Macro setting	0~11	0 (invalid)	×○
F277	Third Acceleration Time (S)	Setting range: 0.1~3000	0 (invalid)	√
F278	Third Deceleration Time (S)			Subject to inverter model √
F279	Fourth Acceleration Time (S)			√
F280	Fourth Deceleration Time (S)			√

## Multifunctional Input and Output Terminals: F300-F340

Function Code	Function Definition	Setting Range	Mfr's Value	Change
F300	Relay token output	0: no function; 1: inverter fault protection; 2: over latent frequency 1; 3: over latent frequency 2; 4: free stop; 5: in running status 1; 6: reserved; 7: Accel/decel time switchover; 8: Reaching the Set Count Value; 9: Reaching the Designated Count Value;	1	√
F301	DO1 token output	10: inverter overload pre-alarm; 11: motor overload pre-alarm; 12: stalling; 13: Inverter is ready to run 14: in running status 2; 15: frequency arrival output; 16: overheat pre-alarm; 17: over latent current output 18: Analog line disconnection protection 19: Under-load protection output 20: Zero current detecting output	14	√
F302	DO2 token output	21: OUT1 controlled by communication 22: OUT2 controlled by communication 23: TA, TC fault relay output controlled by communication 24: Watchdog output token 30: General pump is running 31: Converter pump is running 32: Over-limit pressure token 43: Communication timeout 1 token 45: Lower than setting temperature token 59: oPEn fault representation	5	√
F303	DO output types selection	0: level output 1 : pulse output	0	√
F304	S curve beginning stage proportion	2.0~50.0	30.0	√
F305	S curve ending stage proportion	2.0~50.0	30.0	√
F306	Accel/decel mode	0: Straight-line 1: S curve	0	×
F307	Characteristic frequency 1 (Hz)	F112~F111	10.00	√
F308	Characteristic frequency 2(Hz)	F112~F111	50.00	√
F309	Characteristic frequency width (%)	0~100	50%	√
F310	Characteristic current (A)	0~5000	Rated current	√○
F311	Characteristic current width (%)	0~100	10	√

F312	Frequency arrival threshold (Hz)	0.00~5.00	0.00	√
F313	Count frequency divisions	1~65000	1	√
F314	Set count value	F315~65000	1000	√
F315	Designated count value	1~F314	500	√
F316	DI1 terminal function setting	0: no function; 1: running terminal; 2: stop terminal; 3: multi-stage speed terminal 1; 4: multi-stage speed terminal 2; 5: multi-stage speed terminal 3; 6: multi-stage speed terminal 4;	11	√
F317	DI2 terminal function setting	7: reset terminal; 8: free stop terminal; 9: external emergency stop terminal; 10: acceleration/deceleration forbidden terminal;	9	√
F318	DI3 terminal function setting	11: forward run jogging; 12: reverse run jogging; 13: UP frequency increasing terminal; 14: DOWN frequency decreasing ; 15: "FWD" terminal; 16: "REV" terminal;	15	√
F319	DI4 terminal function setting	17: three-line type input "X" terminal; 18: accel/decel time switchover 1; 19: Reserved;	16	√
F320	DI5 terminal function setting	20: Switchover between speed and torque 21: frequency source switchover terminal; 22: Count input terminal; 30: Water lack signal; 31: Signal of water 32: Fire pressure switchover; 33: Emergency fire control	7	√
F321	DI6 terminal function setting	34: Accel / decel switchover 2 35: Macro switchover 1 36: Macro switchover 2 37: Common-open PTC heat protection	8	√
F322	DI7 terminal function setting	38: Common-close PTC heat protection 42: oPEn protection terminal 49: PID pause 53: Watchdog 54: Frequency reset 55~59: Reserved	0	√
F323	DI8 terminal function setting	60: Communication timeout 2 elimination 61: Start/stop terminals	0	√
F324	Free stop terminal logic	0: positive logic (valid for low level);	0	×

F325	External emergency stop terminal logic	1: negative logic (valid for high level)	0	×
F326	Watchdog time	0.0: Invalid 0.1~3000.0	10.0	√
F327	Stop mode	0: Free to stop 1: Deceleration to stop	0	×
F328	Terminal filter times	1~100	20	√
F329	Power-on terminal running command	0: command enabled 1: command disabled	0	√
F330	Status display of digital input terminals	Status of DIX terminals		△○
F331~ F334	Reserved			
F335	Relay output simulation	0: Output inactive. 1: Output active.	0	×
F336	DO1 output simulation		0	×
F337	DO2 output simulation		0	×
F338	AO1 output simulation	Setting range: 0~4095	0	×
F339	AO2 output simulation	Setting range: 0~4095	0	×
F340	DI terminal negative logic	Setting range: 0: Invalid 1: DI1 negative logic 2: DI2 negative logic 4: DI3 negative logic 8: DI4 negative logic 16: DI5 negative logic 32: DI6 negative logic 64: DI7 negative logic 128: DI8 negative logic	0	√
F360	Output terminal negative logic	0: Invalid 1: DO1 negative logic 2: DO2 negative logic 4: Relay 1	0	√
F343	Delay time of DI1 ON	0.00~99.99	0.00	√
F344	Delay time of DI2 ON		0.00	√
F345	Delay time of DI3 ON		0.00	√
F346	Delay time of DI4 ON		0.00	√
F347	Delay time of DI5 ON		0.00	√
F348	Delay time of DI6 ON		0.00	√

F349	Delay time of DI7 ON		0.00	✓
F350	Delay time of DI8 ON		0.00	✓
F351	Delay time of DI1 OFF		0.00	✓
F352	Delay time of DI2 OFF		0.00	✓
F353	Delay time of DI3 OFF		0.00	✓
F354	Delay time of DI4 OFF		0.00	✓
F355	Delay time of DI5 OFF		0.00	✓
F356	Delay time of DI6 OFF		0.00	✓
F357	Delay time of DI7 OFF		0.00	✓
F358	Delay time of DI8 OFF		0.00	✓
F359	Stop command priority	0: Invalid 1: Valid	0	✓
F360	DO terminal negative logic	0: Invalid 1: DO1 negative logic 2: DO2 negative logic 4: Relay 1	0	✓

## Analog Input and Output: F400-F480

Function code	Function Definition	Setting Range	Mfr's value	Change
F400	Lower limit of AI1 channel input (V)	0.00~F402	0.04	√○
F401	Corresponding setting for lower limit of AI1 input	0.00~2.00	1.00	√
F402	Upper limit of AI1 channel input (V)	F400~10.00	10.00	√○
F403	Corresponding setting for upper limit of AI1 input	0.00~2.00	2.00	√
F404	AI1 channel proportional gain K1	0.0~10.0	1.0	√
F405	AI1 filtering time constant (S)	0.01~10.0	0.10	√
F406	Lower limit of AI2 channel input (V)	0.00~F408	0.04	√○
F407	Corresponding setting for lower limit of AI2 input	0~F409	1.00	√
F408	Upper limit of AI2 channel input (V)	F406~10.00	10.00	√○
F409	Corresponding setting for upper limit of AI2 input	0.00~2.00	2.00	√
F410	AI2 channel proportional gain K2	0.0~10.0	1.0	√
F411	AI2 filtering time constant	0.01~10.00	0.10	√
F412~ F417	Reserved			
F418	AI1 channel 0Hz voltage dead zone	0.00~1.00	0.00	√
F419	AI2 channel 0Hz voltage dead zone	0.00~1.00	0.00	√
F420~ F422	Reserved			
F423	AO1 output range	0: 0~5V; 1: 0~10V or 0-20mA 2: 4-20mA	1	√
F424	AO1 lowest corresponding frequency	0.0~F425	0.05Hz	√
F425	AO1 highest corresponding frequency	F424~F111	50.00Hz	√
F426	AO1 output compensation	0~120	100	√
F427	AO2 output range	0: 0~20mA; 1: 4~20mA	0	√
F428	AO2 lowest corresponding frequency	0.0~F429	0.05Hz	√

F429	AO2 highest corresponding frequency	F428~F111	50.00Hz	√
F430	AO2 output compensation	0~120	100	√
F431	AO1 analog output signal selecting	0: Running frequency; 1: Output current; 2: Output voltage; 3: AI1 4: AI2 5: Input pulse 6: Output torque 7: Given by PC/PLC 8: Target frequency 9: Actual speed 10: Output torque 2 11: Reserved 12: Output power 13:DO2 output	0	√
F432	AO2 analog output signal selecting		1	√
F433	Corresponding current for full range of external voltmeter	0.01~5.00 times of rated current	2.00	×
F434	Corresponding current for full range of external ammeter		2.00	×
F436	Corresponding current multiple of output max analog to rated torque.	0.01~3.00	3.00	×
F438	AI1 input type	0: voltage 1: Current	0	×○
F439	AI2 input type	0: voltage 1: Current	1	×○
F440	Min frequency of input pulse FI	0.00~F442	0.00	√
F441	Corresponding setting of FI min frequency	0.00~F443	1.00	√
F442	Max frequency of input pulse FI	F440~100.00	10.00	√
F443	Corresponding setting of FI max frequency	Max (1.00, F441) ~2.00	2.00	√
F444	Reserved			
F445	Filtering constant of FI input pulse	0~1000	0	√
F446	FI channel 0Hz frequency dead zone	0~F442Hz (Positive-Negative)	0.00	√
F447-F448	Reserved			
F449	Max frequency of output pulse FO	0.00~100.00	10.00	√
F450	Zero bias coefficient of output pulse frequency (%)	0.0~100.0	0.0%	√
F451	Frequency gain of output pulse	0.00~10.00	1.00	√
F452	Reserved			

F453	Output pulse signal	0: Running frequency 1: Output current 2: Output voltage 3: AI1 4: AI2 5: Input pulse 6: Output torque 7: Given by PC/PLC 8: Target frequency	0	√
F460	AI1 channel input mode	0: straight line mode 1: folding line mode	0	√
F461	AI2 channel input mode	0: straight line mode 1: folding line mode	0	√
F462	AI1 insertion point A1 voltage value	F400~F464	2.00V	√
F463	AI1 insertion point A1 setting value	0.00~2.00	1.20	√
F464	AI1 insertion point A2 voltage value	F462~F466	5.00V	√
F465	AI1 insertion point A2 setting value	0.00~2.00	1.50	√
F466	AI1 insertion point A3 voltage value	F464~F402	8.00V	√
F467	AI1 insertion point A3 setting value	0.00~2.00	1.80	√
F468	AI2 insertion point B1 voltage value	F406~F470	2.00V	√
F469	AI2 insertion point B1 setting value	0.00~2.00	1.20	√
F470	AI2 insertion point B2 voltage value	F468~F472	5.00V	√
F471	AI2 insertion point B2 setting value	0.00~2.00	1.50	√
F472	AI2 insertion point B3 voltage value	F470~F408	8.00V	√
F473	AI2 insertion point B3 setting value	0.00~2.00	1.80	√

### Multi-stage Speed Control: F500-F580

F500	Stage speed type	0: 3-stage speed; 1: 15-stage speed; 2: Max 8-stage speed auto circulating	1	×
F501	Selection of Stage Speed Under Auto-circulation Speed Control	2~8	7	√
F502	Selection of Times of Auto- Circulation Speed Control	0~9999 (when the value is set to 0, the inverter will carry out infinite circulating)	0	√
F503	Status after auto circulation running Finished	0: Stop 1: Keep running at last stage	0	√



		speed		
F504	Frequency setting for stage 1 speed	F112~F111	5.00	√
F505	Frequency setting for stage 2 speed	F112~F111	10.00	√
F506	Frequency setting for stage 3 speed	F112~F111	15.00	√
F507	Frequency setting for stage 4 speed	F112~F111	20.00	√
F508	Frequency setting for stage 5 speed	F112~F111	25.00	√
F509	Frequency setting for stage 6 speed	F112~F111	30.00	√
F510	Frequency setting for stage 7 speed	F112~F111	35.00	√
F511	Frequency setting for stage 8 speed	F112~F111	40.00	√
F512	Frequency setting for stage 9 speed	F112~F111	5.00	√
F513	Frequency setting for stage 10 speed	F112~F111	10.00	√
F514	Frequency setting for stage 11 speed	F112~F111	15.00	√
F515	Frequency setting for stage 12 speed	F112~F111	20.00	√
F516	Frequency setting for stage 13 speed	F112~F111	25.00	√
F517	Frequency setting for stage 14 speed	F112~F111	30.00	√
F518	Frequency setting for stage 15 speed	F112~F111	35.00	√
F519-F 533	Acceleration time setting for the speeds from Stage 1 to stage 15	0.1~3000S	Subject to inverter model	√
F534-F 548	Deceleration time setting for the speeds from Stage 1 to stage 15	0.1~3000S		√
F549-F 556	Running directions of stage speeds from Stage 1 to stage 8	0: forward running; 1: reverse running	0	√
F557-F 564	Running time of stage speeds from Stage 1 to stage 8	0.1~3000S	1.0	√
F565-F 572	Stop time after finishing stages from Stage 1 to stage 8.	0.0~3000S	0.0	√
F573-F 579	Running directions of stage speeds from Stage 9 to stage 15.	0: forward running; 1: reverse running	0	√
F580	Stage speed mode selection	0: Stage speed mode 1 1: Stage speed mode 2	0	×

### Auxiliary Functions: F600-F650

F600	DC Braking Function Selection	0: Invalid; 1: braking before starting; 2: braking during stopping; 3: braking during starting and stopping	0	×
F601	Initial Frequency for DC Braking (Hz)	0.20~50.00	1.00	√
F602	DC Braking efficiency before Starting	≤30kW: 0~250	50	√
F603	DC Braking efficiency During Stop	>30kW: 0~200		
F604	Braking Lasting Time Before Starting	0.00~30.00	0.50	√
F605	Braking Lasting Time During Stopping	0.00~30.00	0.50	√
F606	Reserved			
F607	Selection of Stalling Adjusting Function	0~2: Reserved 3: Voltage/current control	3	√○

		4: Voltage control 5: Current control		
F608	Stalling Current Adjusting (%)	25~FC49	160	√
F609	Stalling Voltage Adjusting (%)	110~200	S2/T2: 130 T3: 140	√○
F610	Stalling Protection Judging Time(S)	0.0: disabled; 0.1~3000.0	0.0	√
F611	Dynamic Braking threshold (V)	T3: 600~2000 S2/T2: 320~2000	Subject to inverter model	×○
F612	Dynamic braking duty ratio (%)	0~100	100	√
F613	Speed track	0: invalid 1: valid 2: valid at the first time	0	×
F614	Speed track mode	0: Speed track from frequency memory 1: Speed track from max frequency 2: Speed track from frequency memory and direction memory	0	×
F615	Speed track rate (%)	1~100	20	×
F618	Delay time of speed track (S)	0.5~60.0	1.5	×
F620	Brake delay turn-off time (s)	0.0: discharge not closed when stop 0.1~3000	5.0s	√
F621	LCD background adjustment	0: White background 1: Inverse background	0	√
F638	Parameter copy enable	0: copy forbidden 1: parameter download 1 (voltage level and power accordance) 2: parameters download (without considering voltage level and power)	1	×
F639	Parameter copy code	3000~3499	Subject to model	△○
F640	Parameter copy type	0: Total parameters copy 1: Parameter copy (motor F801~F810/F844 not include)	1	×
F641	Inhibition of current oscillation at low frequency	0~100 0: invalid	Subject to inverter model	×
F643	Multi-functional key	0: Invalid 1: FWD jogging 2. REV jogging 3. Switchover between local/remote	0	√
F644	Keypad copy enabled	0: Invalid 1: Current macro upload	0	×

		2: Current macro download 3: User macro 1 parameters upload 4: User macro 1 download 5: User macro 2 parameters upload 6: User macro 2 download		
F645	Status parameters selection	0: Running frequency 1: Rotation speed 2: Target speed 3: Output current 4: Output voltage 5: DC bus voltage 6: PID setting value 7: PID feedback value 8: Radiator temperature 9: Count value 10: Linear speed 11: Channel for main frequency 12: Main frequency 13: Channel for accessorial frequency 14: Accessorial frequency 15: Target frequency 16: Reserved 17: Output torque 18: Setting torque 19: Motor power 20: Output power 21: Running status 22: DI terminal status 23: Output terminal status 24: Stage speed of multi-stage speed 25: AI1 input value 26: AI2 input value 27, 28: Reserved 29: Pulse input frequency 30: Pulse output frequency 31: AO1 output percent 32: AO2 output percent 33: Power on Hours	0	√
F646	Backlight time of LCD (S)	0~100	100	√
F647	Language selection	0: Chinese 1: English 2: Deutsch	0	√○
F648~ F655	Reserved			
F656	DC braking waiting time during	0.00-30.00	0	√○

	stop	(only valid in vector control mode)		
F657	Instantaneous power failure selection	0: Invalid 1: Valid 2: Decelerate to stop	0	×
F658	Voltage rally acceleration time	0.0~3000s 0.0: F114 original acceleration speed	0.0	√
F659	Voltage rally deceleration time	0.0~3000s 0.0: F115 Original deceleration speed	0.0	√
F660	Action judging voltage at instantaneous power failure	200~F661	Subject to the inverter model	×○
F661	Action stop voltage at instantaneous power failure	F660~1400	Subject to the inverter model	×○
F662	Instantaneous voltage recovery judging time(s)	0.00~10.00	0.30	√
F663~ F669	Reserved			
F670	Voltage-limit current-limit adjustment coefficient	0.01~10.00	2.00	√
F671	voltage source for V/F separation	0: F672 1: AI1 2: AI2 4: Communication setting 5: Pulse setting 6: PID given 7~10: Reserved	0	×
F672	Voltage digital setting for V/F separation	0.00~100.00	100.00	√
F673	Lower limit of voltage at V/F separation (%)	0.00~F633	0.00	×
F674	Upper limit of voltage at V/F separation (%)	F632~100.00	100.00	×
F675	Voltage rise time of V/F separation	0.0~3000.0	5.0	√
F676	Voltage rise time of V/F separation	0.0~3000.0	5.0	√
F677	Stop mode at V/F separation	0: voltage/frequency declines to 0 according to respective time. 1: Voltage declines to 0 firstly 2: frequency declines to 0 firstly.	0	×

## Timing Control and Protection: F700-F770

Function Codes	Definition	Setting Range	Mfr's value	Change
F700	Selection of terminal free stop mode	0: free stop immediately; 1: delayed free stop	0	√
F701	Delay time for free stop and programmable terminal action	0.0~60.0s	0.0	√
F702	Fan control mode	0: Controlled by temperature 1: Running when inverter is powered on 2: Controlled by running status	2	√
F704	Inverter Overloading pre-alarm Coefficient (%)	50~100	80	×
F705	Overloading adjusting gains(%)	50~100	80	×
F706	Inverter Overloading coefficient%	120~190	150	×
F707	Motor Overloading coefficient %	20~100	100	×
F708	Record of The Latest Malfunction Type	Setting range: 2: Over current (OC) 3: over voltage (OE) 4: input phase loss (PF1) 5: inverter overload (OL1) 6: under voltage (LU) 7: overheat (OH) 8: motor overload (OL2) 11: external malfunction (ESP)		△○
F709	Record of Malfunction Type for Last but One	12: current error before running (Err3) 13. studying parameters without motor (Err2) 15: Current sampling fault (Err4) 16: Over current 1 (OC1) 17: output phase loss (PF0) 18: Aerr analog disconnected		△○
F710	Record of Malfunction Type for Last but Two	19: EP3 under-load 20: EP/EP2 under-load 22: nP pressure control 23: Err5 PID parameters are set wrong 32: PMSM distuning fault (PCE) 46: Speed track fault (FL) 49: Watchdog fault (Err6) 50: STO fault		△○

F711	Fault Frequency of The Latest Malfunction (Hz)			△○
F712	Fault Current of The Latest Malfunction (A)			△○
F713	Fault PN Voltage of The Latest Malfunction (V)			△○
F714	Fault Frequency of Last Malfunction but two (Hz)			△○
F715	Fault Current of Last Malfunction but two (A)			△○
F716	Fault PN Voltage of Last Malfunction but two (V)			△○
F717	Fault Frequency of Last Malfunction but three (Hz)			△○
F718	Fault Current of Last Malfunction but three (A)			△○
F719	Fault PN Voltage of Last Malfunction but three (V)			△○
F720	Record of overcurrent protection fault			△○
F721	Record of overvoltage protection fault			△○
F722	Record of overheat protection fault			△○
F723	Record of overload protection fault			△○
F724	Input phase loss	0: invalid; 1: valid	S2: 0 T2/T3:1	×○
F725	Under-voltage protection	1: Manual reset 2: Auto reset	2	×
F726	Overheat	0: invalid; 1: valid	1	×○
F727	Output phase loss	0: invalid; 1: valid	1	×○
F728	Input phase loss filtering constant	0.1~60.0	5.0	√
F729	Under-voltage filtering constant	1~3000	5.0	√○
F730	Overheat protection filtering constant	0.1~60.0	5.0	√
F732	Voltage threshold of under-voltage protection	Subject to the inverter model	Subject to inverter	×
F737	Over-current 1 protection	0: Invalid 1:Valid	1	×○
F738	Over-current 1 protection coefficient	0.50~3.00	2.50	×
F739	Over-current 1 protection record			△○
F741	Analog disconnected protection	0: Invalid 1: Stop and AErr displays. 2: Stop and AErr is not displayed. 3: Inverter runs at the min frequency. 4: Reserved.	0	√

F742	Threshold of analog disconnected protection (%)	1~100	50	√
F745	Threshold of pre-alarm overheat (%)	0~100	80	√○
F746	Carrier frequency auto-adjusting threshold(°C)	60~72	65	√
F747	Carrier frequency auto-adjusting	0: Invalid 1: Valid	1	√
F751	Fan runs regularly enabled	0: Disabled 1: Enabled	0	√
F754	Zero-current threshold (%)	0~200	5	×
F755	Duration time of zero-current	0~60	0.5	√
F756	Voltage limiting power-on detection delay time (ms)	0: No detection 1~5000	0	√
F757	Voltage limiting stop detection delay time (S)	0.0~100.0	5.0	√
F759	Carrier frequency ratio	3~15	7	×
F760	Grounding protection	0: Invalid 1: Valid	1	*
F761	Switchover mode of FED/REV	0: At zero 1: At start frequency	0	×
F762	Main interface LOGO name	A~Z, a~z, 0~9, special character		√○
F763	Main interface parameter name	A~Z, a~z, 0~9, special character		√○
F764	Main interface parameter unit	A~Z, a~z, 0~9, special character		√○
F765	Main interface parameter coefficient (%)	0.01~200.00	100.00	√○
F770	Auxiliary version number			△○

**Motor parameters: F800-F880**

Function Codes	Definition	Setting Range	Mfr's value	Change
F800	Motor's parameters selection	Setting range: 0: Invalid; 1: Rotating tuning ; 2: Stationary tuning	0	×
F801	Rated power(kW)	0.1~1000	Subject to the inverter model	×○
F802	Rated voltage(V)	1~1300		×○
F803	Rated current	0.2~6553.5		×○
F804	Number of motor poles	2~100	4	×○
F805	Rated rotary speed(rpm)	1~39000		×○
F806	Stator resistance	0.001~65.53Ω (for 15kw and below 15kw) 0.1~6553mΩ (For above 15kw)	Subject to inverter model	×○
F807	Rotor resistance	0.001~65.53Ω (for 15kw and below 15kw) 0.1~6553mΩ (For above 15kw)	Subject to inverter model	×○
F808	Leakage inductance	Setting range: 0.01~655.3mH (for 15kw and below 15kw) 0.001~65.53mH (for above 15kw)	Subject to inverter model	×○
F809	Mutual inductance	Setting range: 0.1~6553mH (for 15kw and below 15kw) 0.01~655.3mH (for above 15 kw)	Subject to inverter model	×○
F810	Motor rated frequency (Hz)	1.00~650.0	50.00	×○
F812	Pre-exciting time(S)	0.00~30.00	0.10	√
F813	Rotary speed loop KP1	1~100.00	30	√
F814	Rotary speed loop KI1	0.01~10.00	0.50	√
F815	Rotary speed loop KP2	1~100.00	Subject to inverter model	√
F816	Rotary speed loop KI2	0.01~10.00	1.00	√
F817	PID switching frequency 1(Hz)	0~F818	5.00	√
F818	PID switching frequency 2(Hz)	F817~F111	10.00	√
F819	Slip coefficient	50~200	100	
F820	Filtering coefficient of speed	0~100	0	√
F822	Upper limit of speed control	0.0~250.0	200	√
F840	Stop speed detection	0: detection according to feedback speed 1: detection according to set speed	0	√○
F844	No-load current	0.1~F803	subject to inverter model	×○



F861	Control mode	0: control mode 1 1: control mode 2	0	×○
F862	Frequency switchover point (%)	0.1~50.0	5.0	×○
F870	PMSM back electromotive force (mV/rpm)	0.1~6553	100	×○
F871	PMSM D-axis inductance	0.01~655.30	5.00	×○
F872	PMSM Q-axis inductance	0.01~655.30	7.00	×○
F873	PMSM stator resistance (Ω)	0.001~65.530 (phase resistor)	0.500	×○
F876	PMSM injection current without load	0.0~100.0	20.0	×○
F877	PMSM injection current compensation without load	0.0~50.0	0.0	×○
F878	PMSM cut-off point of	0.0~50.0	10.0	×○
F879	PMSM injection current with heavy load (%)	0.0~100.0	0.0	×○
F880	PMSM PCE detection time	0.1~10.0	0.2	×○

### Communication parameter: F900-F930

Function Codes	Definition	Setting Range	Mfr's value	Change
F900	Communication Address	1~255: single inverter address 0: broadcast address	1	√
F901	Communication Mode	1: ASCII 2: RTU	2	√○
F902	Reserved			
F903	Parity Check	0: Invalid 1: Odd 2: Even	0	√
F904	Baud Rate	0: 1200; 1: 2400; 2: 4800; 3: 9600; 4: 19200 5: 38400 6: 57600	3	√
F905	Communication timeout period (S)	0.0~3000.0	0.0	√
F906	Reserved			
F907	Time 2 of communication timeout (S)	0.0~3000.0	0.0	√
F911	Master-slave control enabled	0: Disabled 1: Enabled	0	×
F912	Master/slave selection	0: Master 1: Slave	0	×

F913	Slave running command	0: Slave not follow master running command 1: Slave follow master running command 2: Slave water supply mode	1	×
F914	Fault information of slave	Ones: slave fault information 0: Not sending fault information 1: Sending fault information Tens: master's reaction when it loses slave's response 0: No reaction 1: Alarm	01	√
F915	Master action when slave failed	0: continue running 1: free stop 2: Deceleration to stop	1	√
F916	Slave action when master stops	1: Free stop 2: Deceleration to stop	1	√
F917	Slave following master command selection	0: given torque(torque) 1: given frequency 1(Droop) 2: given frequency 2(Droop) 3: slave synchronize in water supply mode	0	√
F918	Zero offset of received data (torque)	0.00~200.00	100.00	√
F919	Gain of received data(torque)	0.00~10.00	1.00	√
F920	Zero offset of received data (frequency)	0.00~200.00	100.00	√
F921	Gain of received data(frequency)	0.00~10.00	1.00	√
F922	window	0.00~10.00	0.50	√
F923	Droop control	0.0(Invalid) 0.1~30.0	0.0	√
F924	Time of communication timeout (S)	0.0~3000.0	0.0	√
F925	Master sending data interval (S)	0.000~1.000	0.0	√
F926	CAN baud rate (kbps)	0: 20 1:50 2:100 3:125 4:250 5:500 6:1000	6	√
F927	Master action when put into slave	0: Stop 1: Remain running	1	×
F930	Keypad disconnected protection(S)	0: Invalid 0~10: 0~10s	0	√

**PID parameters: FA00-FA80**

Function Codes	Definition	Setting Range	Mfr's value	Change
FA00	Water supply mode	0: Single pump (PID control mode) 1: Fixed mode 2: Timing interchanging	0	×
FA01	PID adjusting target given source	0: FA04 1: AI1 2: AI2 4: FI (pulse frequency input)	0	×
FA02	PID adjusting feedback given source	1: AI1 2: AI2 3: FI (pulse frequency input) 4: Communication given 5: Running current 6: Output power 7: Output torque	1	×
FA03	Max limit of PID adjusting (%)	FA04~100.0	100.0	√
FA04	Digital setting value of PID adjusting (%)	FA05~FA03	50.0	√
FA05	Min limit of PID adjusting (%)	0.0~FA04	0.0	√
FA06	PID polarity	0: Positive feedback 1: Negative feedback	1	×
FA07	Dormancy function selection	0: Valid 1: Invalid	1	×
FA09	Min frequency of PID adjusting (Hz)	MAX (F112, 0.1)~F111	5.00	√
FA10	Dormancy delay time (S)	0~500.0	15.0	√
FA11	Wake delay time (S)	0.0~3000	3.0	√
FA12	PID output max frequency(Hz)	FA09~F111	50.00	√
FA15	Feedback disconnection protection	0: disabled; 1: enabled	0	√
FA16	Feedback disconnection protection point	0.00~100.00	1.00	√
FA17	Feedback disconnection detection time(s)	1.0~10.0	5.0	√
FA18	Whether PID adjusting target is changed	0: Invalid 1: Valid	1	×
FA19	Proportion Gain P	0.00~10.00	0.3	√
FA20	Integration time I (S)	0.0~100.0S	0.3	√
FA21	Differential time D (S)	0.00~10.00	0.0	√
FA22	PID sampling period (2mS)	1~500	5	√
FA23	PID negative frequency output	0: Invalid 1: Valid	0	√
FA24	Switching Timing unit setting	0: hour 1: minute	0	×
FA25	Switching Timing Setting	1~9999	100	×

FA26	Under-load protection mode	0: No protection 1: Protection by contactor 2: Protection by PID 3: Protection by current	0	×○
FA27	Current threshold of under-load protection (%)	10~150	80	√
FA28	Waking time after protection (min)	0.0~3000	60	√
FA29	PID dead time (%)	0.0~10.0	2.0	√
FA30	Running Interval of restarting converter pump (S)	2.0~999.9s	20.0	√
FA31	Delay time of starting general pumps (S)	0.1~999.9s	30.0	√
FA32	Delay time of stopping general pumps (S)	0.1~999.9s	30.0	√
FA36	Whether No.1 relay is available	0: unavailable 1: available	0	×
FA37	Whether No.2 relay is available	0: unavailable 1: available	0	×
FA38	Proportional gain Kp2	0.00~10.00	0.30	√
FA39	Integral time Ki2(s)	0.1~100.0	0.3	√
FA40	Derivative time Kd2(s)	0.0~10.0	0.0	√
FA41	PI parameter switch mode	0: no switch 1: reserved 2: auto switch 3: reserved	0	×
FA42	Switch error 1	FA05~FA43	0.0	√
FA43	Switch error 2	FA42~FA03	0.0	√
FA47	Sequence of starting No 1 relay	1~20	20	×
FA48	Sequence of starting No 2 relay	1~20	20	×
FA58	Fire pressure given value (%)	0.0~100.0	80.0	√
FA59	Emergency fire mode	0: Invalid 1: Emergency fire mode 1 2: Emergency fire mode 2	0	×
FA60	Running frequency of emergency fire(Hz)	F112~F111	50.0	√
FA62	when emergency fire control terminal is invalid	0: inverter cannot be stopped by manual 1: inverter can be stopped by manual	0	×
FA66	Duration time of under-load protection (S)	0~60	20.0	√
FA67	Dormancy mode	0: dormancy mode 1 1: dormancy mode 2	0	×
FA68	Given pressure offset 1 (%)	0.0~100.0	30.0	√
FA69	Given pressure offset 2 (%)	0.0~100.0	30.0	√

## Torque control parameters: FC00-FC51

Function Codes	Definition	Setting Range	Mfr's value	Change
FC00	Speed/torque control selection	0: Speed control 1: Torque control 2: Terminal switchover	0	√
FC02	Torque accel/decel time (S)	0.1~100.0	1.0	√
FC06	Torque given channel	0: Digital given (FC09) 1: Analog input AI1 2: Analog input AI2 4: Pulse input channel FI 5: Reserved	0	×
FC07	Torque given coefficient	0~3.000	3.000	×
FC08	Reserved			
FC09	Torque given command value (%)	0~300.0	100.0	√
FC10~FC13	Reserved			
FC14	Offset torque given channel	0: Digital given (FC17) 1: Analog input AI1 2: Analog input AI2 4: Pulse input channel FI 5: Reserved	0	×
FC15	Offset torque coefficient	0~0.500	0.500	×
FC16	Offset torque cut-off frequency (%)	0~100.0	10.00	×
FC17	Offset torque command value (%)	0~50.0	10.00	√
FC18~FC21	Reserved			
FC22	Forward speed limited channel	0: Digital given (FC23) 1: Analog input AI1 2: Analog input AI2 4: Pulse input channel FI 5: Reserved	0	×
FC23	Forward speed limited (%)	0~100.0	10.00	√
FC24	Reverse speed limited channel	0: Digital given (FC25) 1: Analog input AI1 2: Analog input AI2	0	×
FC25	Reverse speed limited (%)	0~100.0	10.00	√
FC28	Electric torque limited channel	0: Digital given (FC30) 1: Analog input AI1 2: Analog input AI2 4: Pulse input channel FI 5: Reserved	0	×

FC29	Electric torque limited coefficient	0~3.000	3.000	×
FC30	Electric torque limited (%)	0~300.0	200.0	✓
FC33	Braking torque limited channel	0: Digital given (FC35) 1: Analog input AI1 2: Analog input AI2 4: Pulse input channel FI 5: Reserved	0	×
FC34	Braking torque limited coefficient	0~3.000	3.000	×
FC35	Braking torque limited (%)	0~300.0	200.00	✓
FC48	Torque switchover enabled	0: Invalid 1: Valid	1	×
FC49	Current-limiting point 2 (%)	F608~200	190	✓
FC50	Frequency switchover point 1(Hz)	1.00~FC51	10.00	✓
FC51	Frequency switchover point 2(Hz)	FC50~F111	20.00	✓

### Parameters display(H000~H031):

Function Codes	Definition	Setting Range	Mfr's value	Change
H000	Running frequency / target frequency (Hz)			△ ○
H001	Speed with load / target speed(Hz)			△ ○
H002	Output current (A)			△ ○
H003	Output voltage (V)			△ ○
H004	PN voltage (V)			△ ○
H005	PID feedback value (%)			△ ○
H006	Temperature (°C)			△ ○
H007	Count values			△ ○
H008	Linear speed			△ ○
H009	PID given value (%)			△ ○
H012	Output power			△ ○
H013	Output torque (%)			△ ○
H014	Target torque (%)			△ ○
H016	Voltage limiting reference value (V)			△ ○

H017	Current stage speed for multi-stage speed			△ ○
H018	Input pulse frequency (0.01KHz)			△ ○
H019	Feedback speed (Hz)			△ ○
H020	Feedback speed (rpm)			△ ○
H021	Monitoring AI1			△ ○
H022	Monitoring AI2			△ ○
H024	Reserved			△ ○
H025	Power-On time (min)			△ ○
H026	Running time (min)			△ ○
H027	Input frequency (Hz)			△ ○
H028~ H029	Reserved			
H030	Main frequency X (Hz)			△ ○
H031	Accessorial frequency Y(Hz)			△ ○
H033- H040	Reserved			

**Note:** × indicating that function code can only be modified in stop state.

√ indicating that function code can be modified both in stop and run state.

△ indicating that function code can only be checked in stop or run state but cannot be modified.

○ indicating that function code cannot be initialized as inverter restores manufacturer's value but can only be modified manually.

## Appendix 7 Master/slave control

### I. Overview

Master/slave control means several drives to control same system, which motor shafts are connected together with gear, chain, or conveyor. The load is averagely distributed among all drives. Master is controlled by external signal, master communicates with slaves by cables.

The link types between motors include rigid connection and flexible connection.

Rigid connection means motors are connected by gear, chain or nearer synchronous belt. The speed difference between master and slave is small, master control mode is speed control, slave control mode is torque control.

Flexible connection means motors are connected by conveyor, the speed of master and slave has a tiny difference, master control mode is speed control, and slave control mode is also speed control.

### II. signal connection

1. CAN communication is adopted.
2. CAN communication distance

F926	6	5	4	3	2	1	0
Baud rate (kpbs)	1000	500	250	125	100	50	20
Communication distance (m)	40	130	270	530	620	1300	3300

The distance is measured value in the experiment, it has some difference with actual communication distance. User should adjust the distance according to actual situation, and shielding cable is suggested to be used.

3. Control cables are connected to master, master is connected to slave by communication cable.

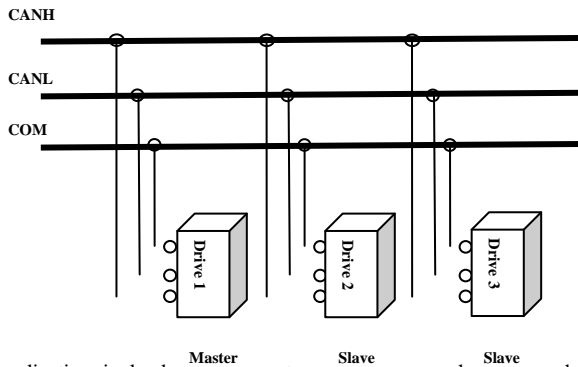

4. When the application is load sharing, motors with same pole pairs and same rated frequency should be selected.



### III. System debugging

Please make sure all cables are connected correctly. Set motor parameters, test control loop and motor running when inverter runs at low frequency in V/F control mode.

Check motor running direction. Each motor should run separately in V/F control mode, all motor running directions should be same, if the running direction is different, please change any two phases of motor.

Before setting master/slave control mode, please study each motor parameters separately.

### IV. Parameters setting

#### 1. Rigid connection

Master: speed mode

Function code	Definition	Setting range	Setting value	Remarks
<b>F106</b>	Control mode	0:Sensorless vector control (SVC); 2: V/F; 3: Vector control 1	<b>0</b>	<b>Must be</b>
F111	Max Frequency (Hz)	F113~650.00	50.00	Same for master/salve
<b>F200</b>	Source of start command	0: Keypad command; 1: Terminal command; 2: Keypad+Terminal; 3:MODBUS; 4: Keypad+Terminal+MODBUS	<b>4</b>	
<b>F201</b>	Source of stop command	0: Keypad command; 1: Terminal command; 2: Keypad+Terminal; 3:MODBUS; 4: Keypad+Terminal+MODBUS	<b>4</b>	<b>Must be</b>
<b>F209</b>	Selecting the mode of stopping the motor	0: stop by deceleration time; 1: free stop 2: Stop by DC braking	<b>1</b>	<b>recommendation</b>
<b>F911</b>	Point-point communication selection	0:Disabled 1:Enabled	<b>1</b>	<b>Must be</b>
<b>F912</b>	Master and slave selection	0:Master 1:Slave	<b>0</b>	<b>Must be</b>
<b>F915</b>	Slave action when master stops	0: continue running 1: free stop 2: Deceleration to stop	<b>1</b>	<b>recommendation</b>
<b>F917</b>	Slave following master command selection	0: given torque(torque) 1: given frequency 1(Droop) 2: given frequency 2 (Droop)	<b>0</b>	<b>Must be</b>
<b>F926</b>	CAN baud rate (kbps)	0:20 1:50 2:100 3:125 4: 250 5:500 6:1000	<b>6</b>	<b>Same for master/salve</b>

## Slave: torque mode

Function code	Definition	Setting range	Setting value	Remarks
<b>F106</b>	Control mode	0:Sensorless vector control (SVC); 2: V/F; 3: Vector control 1	<b>0</b>	<b>Must be</b>
F111	Max Frequency (Hz)	F113~650.00	<b>50.00</b>	<b>Same for master/salve</b>
<b>F200</b>	Source of start command	0: Keypad command; 1: Terminal command; 2: Keypad+Terminal; 3:MODBUS; 4: Keypad + Terminal + MODBUS	<b>4</b>	<b>Must be</b>
<b>F201</b>	Source of stop command	0: Keypad command; 1: Terminal command; 2: Keypad+Terminal; 3:MODBUS; 4: Keypad + Terminal + MODBUS	<b>4</b>	<b>Must be</b>
<b>F203</b>	<b>Main frequency source</b>	<b>10: modbus</b>	<b>10</b>	<b>Must be</b>
<b>F209</b>	Selecting the mode of stopping the motor	0: stop by deceleration time; 1: free stop 2: Stop by DC braking	<b>1</b>	<b>recommendation</b>
<b>F911</b>	Point-point communication selection	0:Disabled 1:Enabled	<b>1</b>	<b>Must be</b>
<b>F912</b>	Master and slave selection	0:Master 1:Slave	<b>1</b>	<b>Must be</b>
<b>F913</b>	Running command of slave	0:Slave not following running commands of master 1:Slave following running commands of master	<b>1</b>	<b>Must be</b>
<b>F914</b>	Fault information of slave	Ones: slave fault information 0: Not sending fault information 1: Sending fault information Tens: master's reaction when it loses slave's response 0: No reaction 1: Alarm	<b>01</b>	<b>Must be</b>
<b>F916</b>	Slave action when master stops	1: Free stop 2: Deceleration to stop	<b>1</b>	<b>Must be</b>
<b>F917</b>	Slave following master command selection	0: given torque(torque) 1: given frequency 1(Droop) 2: given frequency 2 (Droop)	<b>0</b>	<b>Must be</b>
<b>F922</b>	<b>window</b>	<b>0.00~10.00</b>	<b>0.50</b>	
<b>FC00</b>	Speed/torque	0: Speed control	<b>1</b>	<b>Must be</b>

	control selection	1: Torque control 2: Terminal switchover		
<b>FC06</b>	Torque given channel	0: Digital given (FC09) 1: Analog input AI1 2: Analog input AI2 3: Analog input AI3 4: Pulse input channel FI 5: Reserved	<b>5</b>	<b>Must be</b>
<b>F926</b>	CAN baud rate (kbps)	0:20 1:50 2:100 3:125 4: 250 5:500 6:1000	<b>6</b>	<b>Same for master/salve</b>

## 2. flexible connection

Master: speed mode

Function code	Definition	Setting range	Setting value	Remarks
<b>F111</b>	Max Frequency (Hz)	F113~650.00	<b>50.00</b>	<b>Same for master/salve</b>
<b>F200</b>	Source of start command	0: Keypad command; 1: Terminal command; 2: Keypad+Terminal; 3:MODBUS; 4: Keypad + Terminal + MODBUS	4	Must be
<b>F201</b>	Source of stop command	0: Keypad command; 1: Terminal command; 2: Keypad+Terminal; 3:MODBUS; 4: Keypad + Terminal + MODBUS	4	Must be
<b>F209</b>	Selecting the mode of stopping the motor	0: stop by deceleration time; 1: free stop 2: Stop by DC braking	1	recommendation
<b>F911</b>	Point-point communication selection	0:Disabled 1:Enabled	1	Must be
F912	Master and slave selection	0:Master 1:Slave	0	Must be
F915	Slave action when master stops	1: Free stop 2: Deceleration to stop	1	recommendation
F917	Slave following master command selection	0: given torque(torque) 1: given frequency 1(Droop) 2: given frequency 2 (Droop)	1	Must be
F926	CAN baud rate (kbps)	0:20 1:50 2:100 3:125 4: 250 5:500 6:1000	6	Same for master/salve

## Slave: speed mode

Function code	Definition	Setting range	Setting value	Remarks
F111	Max Frequency (Hz)	F113~590.00	50.00	Same for master/salve
F200	Source of start command	0: Keypad command; 1: Terminal command; 2: Keypad+Terminal; 3:MODBUS; 4: Keypad + Terminal + MODBUS	4	Must be
F201	Source of stop command	0: Keypad command; 1: Terminal command; 2: Keypad+Terminal; 3:MODBUS; 4: Keypad + Terminal + MODBUS	4	Must be
F203	Main frequency source	10: modbus	10	Must be
F209	Selecting the mode of stopping the motor	0: stop by deceleration time; 1: free stop 2: Stop by DC braking	1	recommendation
F911	Point-point communication selection	0:Disabled 1:Enabled	1	Must be
F912	Master and slave selection	0:Master 1:Slave	1	Must be
F913	Running command of slave	0:Slave not following running commands of master 1:Slave following running commands of master	1	Must be
F914	Fault information of slave	Ones: slave fault information 0: Not sending fault information 1: Sending fault information Tens: master's reaction when it loses slave's response 0: No reaction 1: Alarm	01	Must be
F916	Slave following master command selection	0: given torque(torque) 1: given frequency 1(Droop) 2: given frequency 2 (Droop)	1	Must be
F917	Slave following master command selection	0: given torque(torque) 1: given frequency 1(Droop) 2: given frequency 2	1	Must be

		(Droop)		
F923	Droop control	0.0 (Invalid) 0.1~30.0	0.0	
F926	CAN baud rate (kbps)	0:20 1:50 2:100 3:125 4: 250 5:500 6:1000	6	Same for master/salve

Note: user must set the parameters according to the table when the parameters' remarks are "must be".

#### V. Remarks

1. If baud rate must be decreased because of equipment distance, the time interval of master sending command must be extended.
2. The rated frequency of master and slave must be same.
3. The control mode (F106) of master and slave must be same.
4. Direction of master and slave must be same.
5. When rigid connection and in torque control, if slave cannot start because of low torque, torque bias should be increased.

2018041013A